

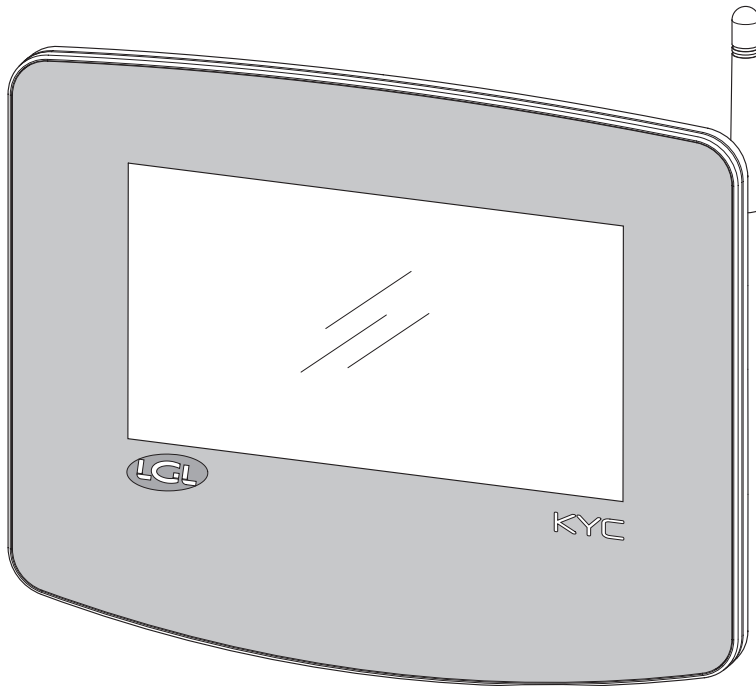

KYC TOUCH

MANUALE DI ISTRUZIONE
INSTRUCTION MANUAL
NOTICE D'INSTRUCTION
BEDIENUNGSANLEITUNG
MANUAL DE INSTRUCCION
EL KİTABI
使用手冊
取扱説明書





Scope of supply: Design, manufacture and after sales service of yarn and weft feeders, measuring winders, stands, creels and oil systems for textile machinery.

TRADUZIONI DELLE ISTRUZIONI ORIGINALI.
 TRANSLATION OF THE ORIGINAL INSTRUCTIONS.
 TRADUCTIONS DES INSTRUCTIONS D'ORIGINE.
 ÜBERSETZUNG DER ORIGINALANLEITUNGEN.
 TRADUCCIÓN DE LAS INSTRUCCIONES ORIGINALES.
 ORJINAL TALÍMATLARIN TERCÜMESİ.
 原始使用说明书的翻译。
 オリジナル命令を翻訳。

INDOOR USE ONLY

	AT	BE	BG	CH	CY	CZ	DE
	DK	EE	EL	ES	FI	FR	HR
	HU	IE	IT	IS	LI	LT	LU
	LV	MT	NL	NO	PL	PT	RO
	SE	SI	SK	TR	UK (NI)		

L.G.L. Electronics is gratified by your choice
and thanks you for the preference

communication interface INSTRUCTION MANUAL

KYC TOUCH

ISSUED BY:

Service
Manager

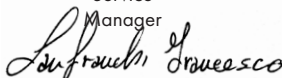
Handwritten signature of Luca Franchi in black ink.

Date: 04/11/2024

APPROVED BY:

Technical
Manager

Handwritten signature of Giovanni Pedrini in black ink.

Date: 04/11/2024

WARNINGS



Power supply

- Use only the cable with custom connector and power the device according to the manufacturer's instructions;
- Do not make connections with wet hands;
- Make sure the cable and/or connector are not damaged before use;
- Avoid passing the cable through areas where it can be crushed or damaged;
- In the event of a malfunction, do not open the device. Contact the Manufacturer and disconnect the power connector;
- Install the device in systems that comply with current regulations;

Use and maintenance of devices

- Keep the device away from heat sources (such as radiators);
- Do not place the device on inclined or unstable surfaces;
- Do not place the device on vibrating surfaces;
- Do not expose the device to corrosive materials, water, steam, and do not keep it in humid places;
- Do not expose the device to the risk of impact or shock;
- In any case, do not touch exposed electrical circuits. Contact could cause an electric shock;
- Before proceeding with cleaning operations, disconnect the device from the power supply. To clean the external surfaces, use a soft, dry or slightly damp cloth. Avoid the use of solvents and chemical products, which can compromise the quality of the components.

Please read this manual carefully and keep it for future reference. The manufacturer is not responsible for damage caused by misuse or incorrect application of the instructions.

This publication may include inaccuracies or typographical errors. The following information is subject to periodic changes that will be included in subsequent versions and made available on company website.

Improvements and/or changes to the product and software described in this document may be made at any time without notice.

WARNINGS



Disposal

The decommissioned device must be disposed of in accordance with the regulations in force in the user's country regarding the disposal of devices with electronic components.

Declaration of conformity

The company LGL ELECTRONICS S.P.A. with registered office in Via Ugo Foscolo, 156 – 24024 Gandino (BG), as manufacturer, declares under its own responsibility, that the product Brand LGL Model: KYC Touch, is operating with the following parameters:

- Operating frequency 2.4 GHz: 2.400 - 2.4835 GHz
- Operating frequency 5 GHz: 5.15 – 5.35 GHz , 5.47 – 5.725 GHz
- Max Power E.I.R.P. at the frequency 2.4 Ghz: 16.59 dBm;
- Max Power E.I.R.P. at the frequency 5 Ghz: 17.68 dBm;
- Firmware Version: IW416-V0, RF878X, FP91, 16.91.10.p214, WPA2_CVE_FIX 1, PVE_FIX 1

and complies with the RED Directive 2014/53/EU.

The full declaration of conformity is available in the attachment at the end of this manual.

INDEX

1	GENERAL FEATURES	8
2	MAIN SCREEN	12
2.1	Machine in run state (main screen background color is green)	12
2.2	Machine in stop state (main screen background color is red)	14
3	FEEDERS IN ALARM	15
4	READ/WRITE PARAMETERS	16
4.1	Parameter change	17
4.2	Parameter for feeders in the selected group	18
4.3	Change parameter's value	19
4.4	Create/manage groups	21
4.5	Groups associations	23
5	SMART UTILITY FUNCTION	24
5.1	Offset	25
6	INFORMATION	26
6.1	Diagnostic page	27
6.2	KYC firmware update	28
7	ACCESS LEVEL	31
8	GENERAL SETTINGS	33
8.1	Network settings	34

INDEX

9	KLS FUNCTION	35
9.1	KLS function with belt sensor	36
10	YCM FUNCTION (YARN CONSUMPTION)	38
10.1	YCM: feeders in group	39
10.2	Yarn settings	40
10.3	YCM general settings	41
10.4	Belt feeder settings	42
10.5	YCM report save on USB pen	45
11	GRAPH OF PARAMETERS	48
12	SYNCHRONOUS YARN FEEDING FUNCTION (SYF)	51
12.1	SYF tuning	54
12.2	SYF in standby mode	55
13	YARN SPEED CONTROL (YSC)	56
13.1	YSC tuning	57
13.2	YSC procedure	58
14	WARPER FUNCTION (ONLY FOR TWIN FEEDERS)	59
15	DATA ANALYSIS AND REMOTE CONTROL	61

1 - GENERAL FEATURES

The KYC device is a communication interface that is connecting the user to the yarn feeders' system.

It is made by a 7 inches display and by some connectors for I/O devices.

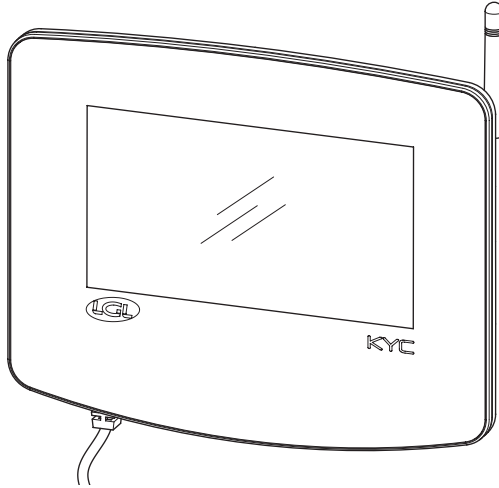

Fig. 1

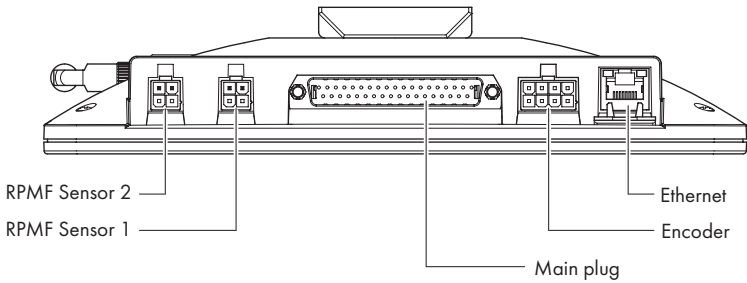
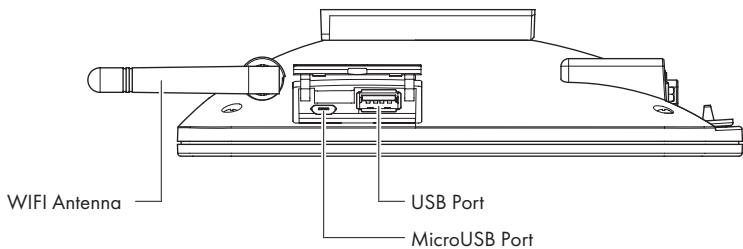

Fig. 2



1 - GENERAL FEATURES

Intended uses:

The KYC device is a communication interface that is connecting the user to the yarn feeders' system.

It is made by a 7 inches display and by some connectors for I/O devices.

Unintended uses:

Unintended uses are all uses not explicitly indicated in Intended uses, in particular:

- electrical power supply different from the one specified
- use of the machine in an explosive atmosphere.

Functional features:

- Simultaneous management of all installed feeders on the machine. Allows the same functions via laptop/tablet (USB) and ERP systems (wifi-ethernet).
- The machine configuration can be saved and loaded later.
- KLS: automatic machine stop in case of yarn break after the feeder
- YCM: information on yarn consumption
- YCC: automatic machine stop if yarn consumption is outside the set range
- YSC: Synchronization of yarn consumption for a selected group of feeders
- SYF: Synchronization of yarn consumption for a selected group of positive feeders
- Remote technical assistance
- Predictive maintenance

1 - GENERAL FEATURES

Technical features:

- Dimensions (W x H x D): 230x180x48 (mm)
- Weight: 800 g
- Power supply: 48V – 60V DC //Current limit 1A (fuse)

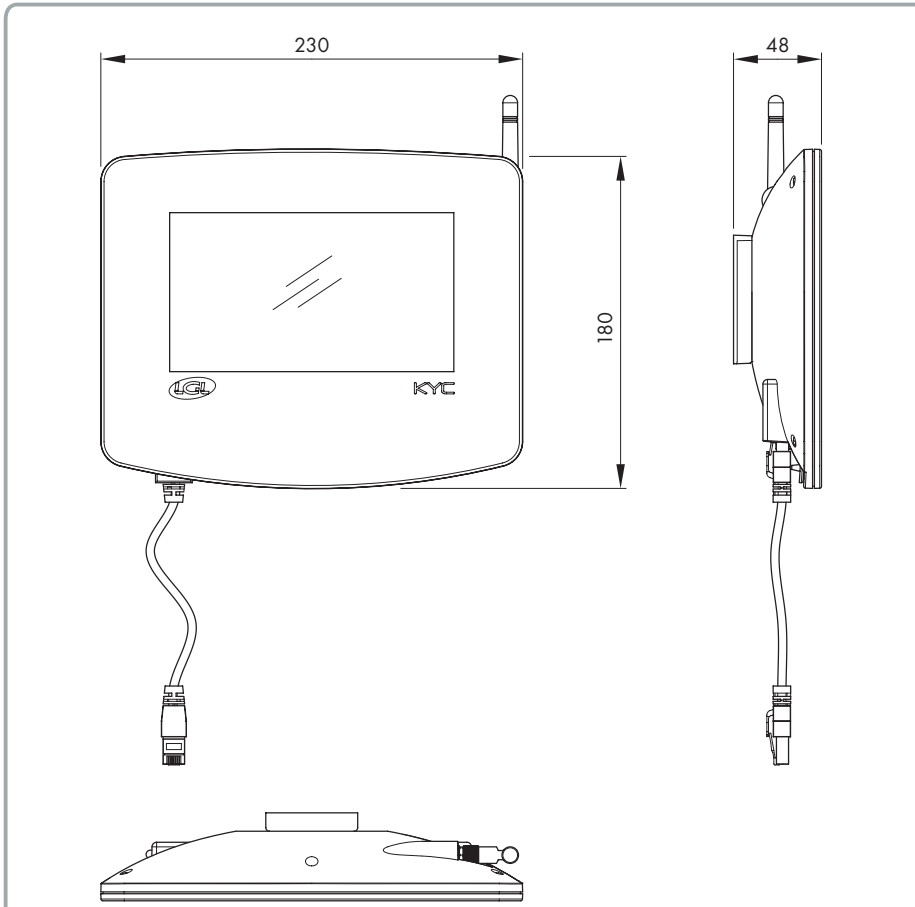

Operation and storage conditions:

- Operating temperature: +10°C to +40°C
- Storage temperature: -20°C to +70°C
- Operating relative humidity: 10% to 90%
- Storage relative humidity: 5% to 95%

Power supply:

Max active power 10W

1 - GENERAL FEATURES

Ports and interfaces:

MAIN	Power, 3 isolated CANBUS, Run, Round pulse, Stop, Inverter Speed, Optional In/Out Signals
LAN	1 LAN port via RJ45 socket (standard Ethernet 10-100 Base-T)
USB	1 USB host controllers (version 2.0) 1 Micro USB
BELT SENSORS	2 Molex 4p Belt sensors connectors
ENCODER	1 Molex 8p incremental encoder connector
WIRELESS LAN	Wireless access point with support wireless LAN radio networks IEEE 802.11b – 11 Mbit/s IEEE 802.11a/g – 54 Mbit/s IEEE 802.11n – 150 Mbit/s

Radio frequencies

Frequency	Range frequencies	Total RF Power	Antenna Peak Gain
2,4 GHz	2.400-2.4835 GHz	16.59 dBm	2.8 dBi
5 GHz	5.15 – 5.35 GHz	17.68 dBm	4.5 dBi
	5.47 – 5.725 GHz		

2 - MAIN SCREEN

2.1 MACHINE IN RUN STATE (MAIN SCREEN BACKGROUND COLOR IS GREEN)

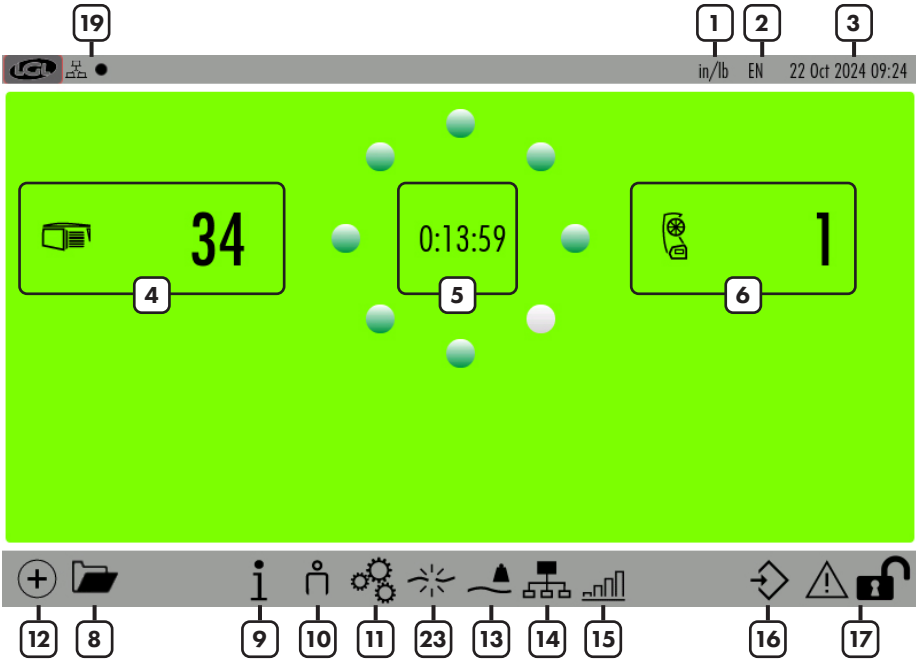

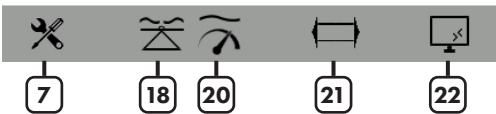

Pic. 3

By pressing  (icon **12**)



Pic. 4

- 1= Unit of measure (to modify press settings icon ).
- 2= Language (to modify press settings icon ).
- 3= Date.
- 4= Number of LGL storage feeders connected.
- 5= Timer (It tells from how long the machine is running or it is standing. It resets when the machine changes state RUN-STOP).
- 6= Number of LGL POSITIVE feeders (TWIN or SPIN) connected.
- 7= Smart Utility function (see chapter 5).

2 - MAIN SCREEN

- 8= Open stored configuration files.
- 9= Information about device (see chapter 6).
- 10= Access level (User or Advanced. Icon 10 is USER. See chapter 7).
- 11= General settings (see chapter 8)
- 12= Page change icon.
- 13= YCM function (see chapter 10).
- 14= Groups and parameters (see chapter 4)
- 15= Parameter graph (see chapter 11).
- 16= Present configurations saving.
- 17= Press and hold to lock the screen (useful to clean the screen))
- 18= SYF function (see chapter 12)
- 19= Network status:



= LAN. The black dot blinks when the device is connected. If there is no connection, the black dot is not present.



=WIFI. The black dot blinks when the device is connected. If there is no connection, the black dot is not present.

- 20 = YSC function (see chapter 13)
- 21 = Warper function (see chapter 14)
- 22 = Data analysis and remote control (see chapter 15)
- 23= KLS function (see chapter 9)



Press and hold  (top left button) to take a screenshot (there must be an external USB key inserted). The image will be saved in the "Screenshot" folder.

2 - MAIN SCREEN

2.2 MACHINE IN STOP STATE (MAIN SCREEN BACKGROUND COLOR IS RED)

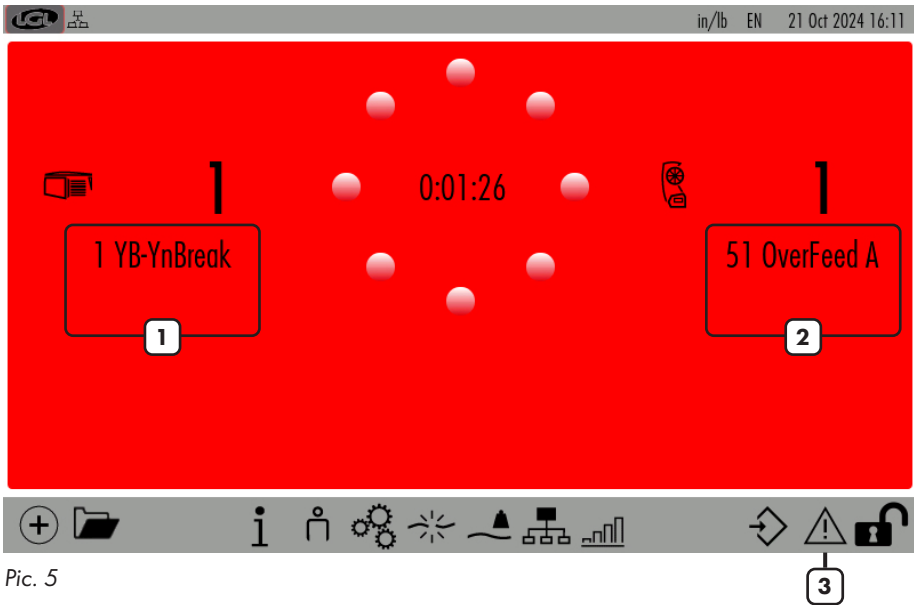

Pic. 5

- 1= Negative feeder ID in alarm with short alarm string.
- 2= Positive feeder ID in alarm with short alarm string.
- 3= Alarm detail (see chapter 2).

3 - FEEDERS IN ALARM

The alarm comes out on the screen as in the following picture:

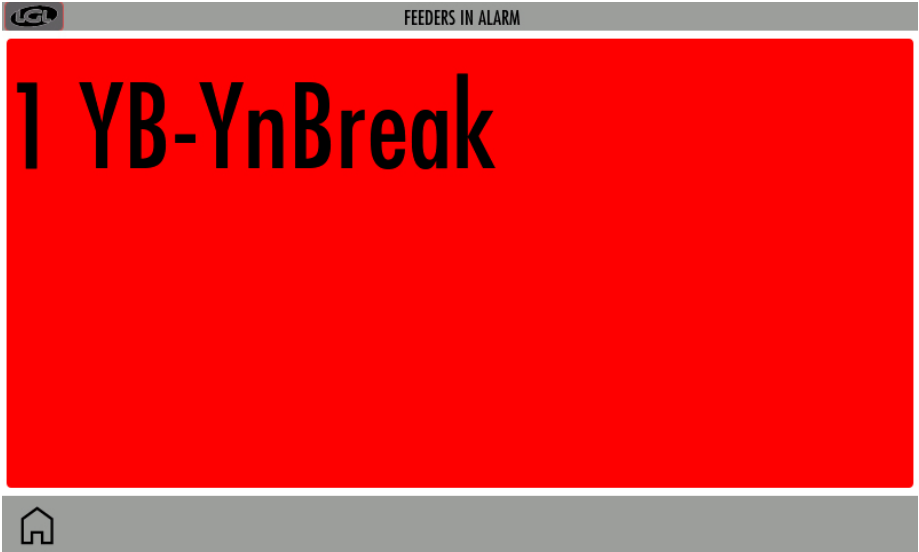

Pic. 6

Pressing  and then  or  , picture 7 appears. A list of all feeders in alarm shows up. Press each button to have more information.

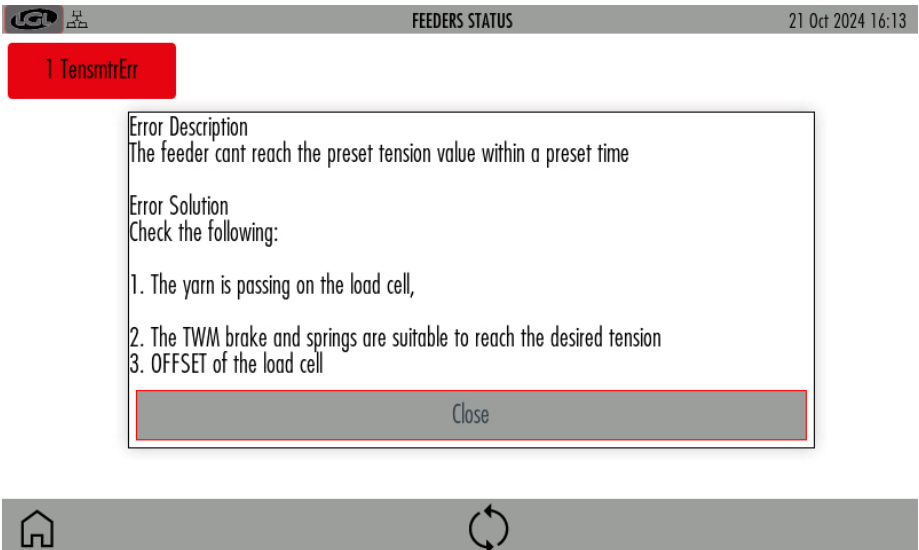

Pic. 7

4 - READ/WRITE PARAMETERS

From main screen (picture 3) press  icon:

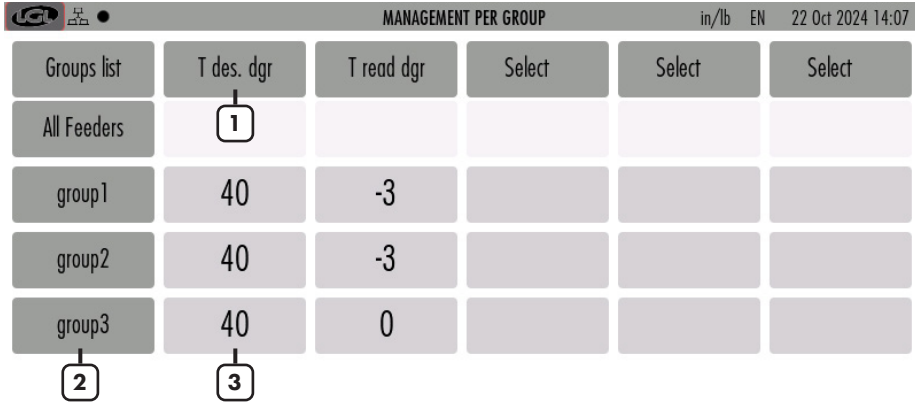

Groups list	T des. dgr	T read dgr	Select	Select	Select
All Feeders	1				
group1	40	-3			
group2	40	-3			
group3	40	0			



Pic.8

On this page you can see, for each group of feeders, 5 parameters. The reported value is the one read by the first feeder of each group.

- 1= Press the parameter's name or the "Select" button to change the viewed parameter (see chapter 4.1)
- 2= Press group button to view information for each feeder of that group (see chapter 4.2)
- 3= Press the button with the value to change the parameter value for all feeders in the group. If it is read-only, a message will appear (see chapter 4.3)

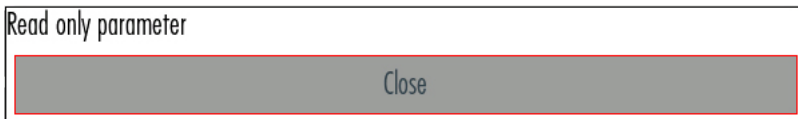

Pic. 9

- 4= Press to create/manage groups (see chapter 4.4)
- 5= Press to delete this configuration.

4 - READ/WRITE PARAMETERS

4.1 PARAMETER CHANGE

On the screen of picture 8 press the parameter's name or "Select":

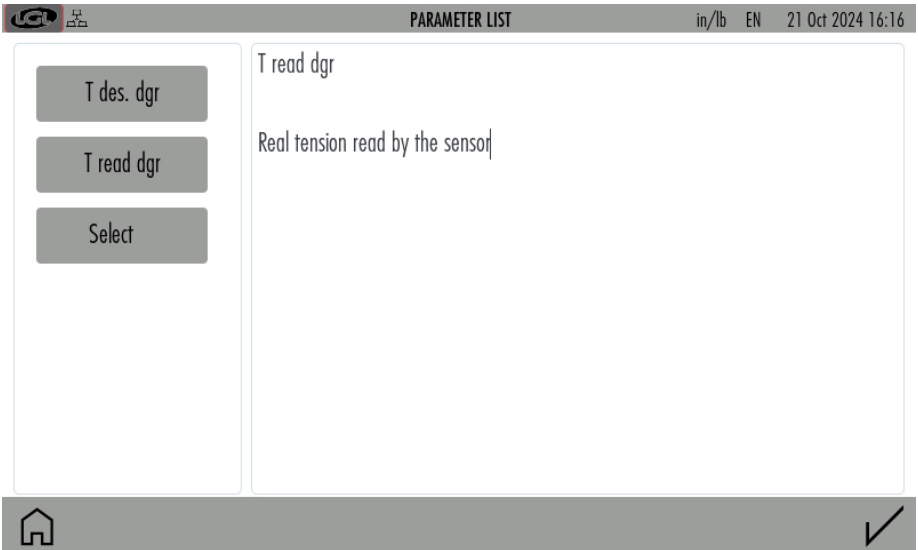

Pic. 10

All the parameters available in the group will appear.
Press on parameter button, right side a description of the parameter appears.

4 - READ/WRITE PARAMETERS

4.2 PARAMETER FOR FEEDERS IN THE SELECTED GROUP

On the screen of picture 8 press group button:

PARAMETERS MANAGEMENT		in/lb	EN	22 Oct 2024 14:02	
group3	T des. dgr	T read dgr	YR-YarnRig	BR-BrkRate	TE-TensErr
51 TWN2039	40	0	5	1	-75



Pic. 11



- 1= Press to move among the groups.
- 2= Press the button with the parameter name or "Select" to change the parameter to view.
- 3= Press the button to change the parameter on the single feeder or on all feeders in the group. See chapter 4.3. If it is read-only, a message will appear (see picture 9).
- 4= Press and insert feeder number to view single feeder values.
- 5= Information: number of feeders in the group.

4 - READ/WRITE PARAMETERS

4.3 CHANGE PARAMETER'S VALUE

Press the button number 3 in picture 8. This is related to one group and the following picture will appear:

PARAMETER VALUE CHANGE		in/lb	EN	22 Oct 2024 09:03
Selected group:	<input type="text" value="group1"/>			
Release:	<input type="text" value="ECM2054"/>	<input type="text" value="1"/>	<input type="text" value="2"/>	<input type="text" value="3"/>
Parameter	<input type="text" value="T des. dgr"/>	<input type="text" value="4"/>	<input type="text" value="5"/>	<input type="text" value="6"/>
Present Value:	<input type="text" value="40"/>	<input type="text" value="7"/>	<input type="text" value="8"/>	<input type="text" value="9"/>
		<input type="text" value="+/-"/>	<input type="text" value="0"/>	<input type="text" value="."/>
Insert new value	<input type="text"/>	<input type="text" value="←"/>	<input type="text" value="Bksp"/>	<input type="text" value="→"/>



Pic. 12

4 - READ/WRITE PARAMETERS

Press the button with the value to change the value on one feeder, and the following picture will appear:

The screenshot shows a screen titled "PARAMETER VALUE CHANGE" with a status bar at the top displaying "in/lb EN 21 Oct 2024 16:19". The main interface consists of several input fields and buttons:

- Feeder:** A text input field containing "51", with a circled "1" pointing to it.
- Release:** A text input field containing "TWN2039".
- Parameter:** A text input field containing "T des. dgr".
- Present Value:** A text input field containing "50".
- Change to all feeders:** A button with a small red square icon, with a circled "2" pointing to it.
- Insert new value:** A button with a vertical line icon, with a circled "3" pointing to it.

To the right of these fields is a numeric keypad with buttons for digits 1-9, "+/-", "0", ".", "<", "Bksp", and ">".



Pic. 13

- 1= Feeder number (Pic 13) or group name (Pic 12).
- 2= It is visible only if you are viewing a specific group. If selected, the parameter value will change for all feeders in the group. Otherwise only for the selected feeder (in the example feeder number 5).
- 3= Insert new value and press ✓.

4 - READ/WRITE PARAMETERS

4.4 CREATE/MANAGE GROUPS

From parameters screen (picture 8) press  icon:

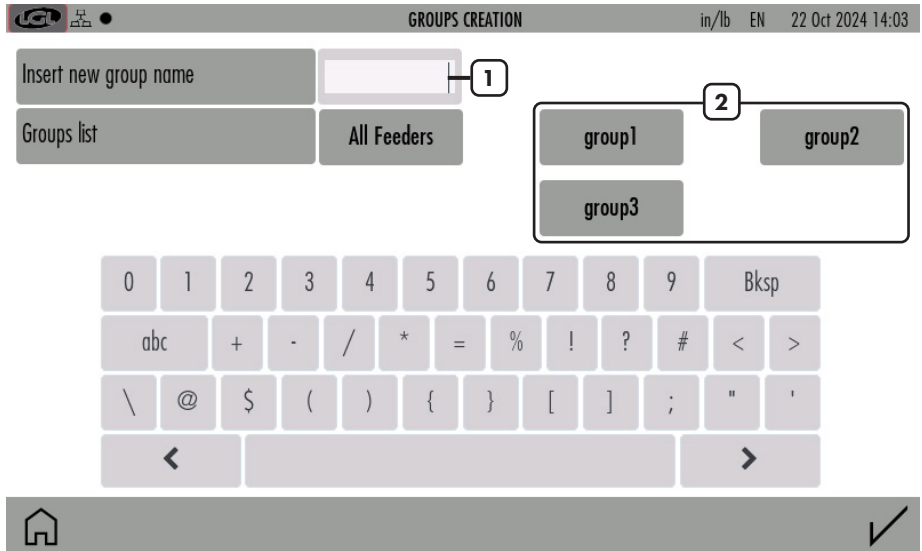

Pic. 14

- 1= Insert the name of the new group and press ✓ to add it in the list.
- 2= List of created groups

To delete or rename a created group, press and hold the name of the group in the list 2.

4 - READ/WRITE PARAMETERS

The following picture appears:



Pic. 15

It is possible to modify the group name. Confirm with ✓.

Cancel the group by pressing —.

As soon as all groups have got their names, press ✓ to continue with the next step, which consists in associating each feeder with its group (4.5).

4 - READ/WRITE PARAMETERS

4.5 GROUPS ASSOCIATIONS

Picture 16 appears:

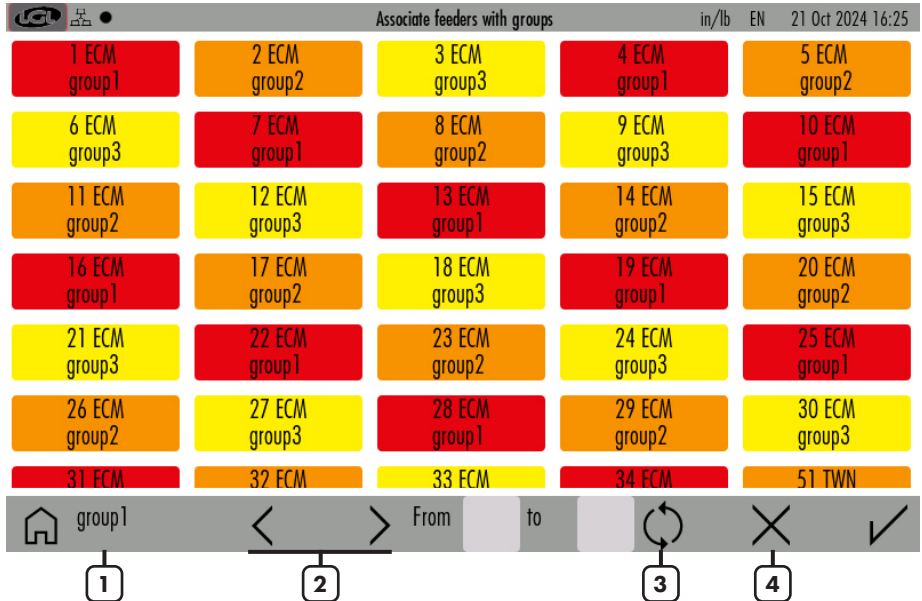

Pic. 16

- 1= Present group name to perform association. Tap on the feeder square to associate the feeder to the group. When the feeder is associated, its square takes a strong color (feeders in the same groups will have the same color). If one feeder is not yet associated with any group, its square is light grey.
- 2= Move among the groups through the arrows.
- 3= Repeat the association to all remaining feeders.
To be used in case the association repeats.
- 4= Delete the association.

In the end press ✓ to confirm association.

5 - SMART UTILITY FUNCTION

From main screen (picture 3) press  icon:

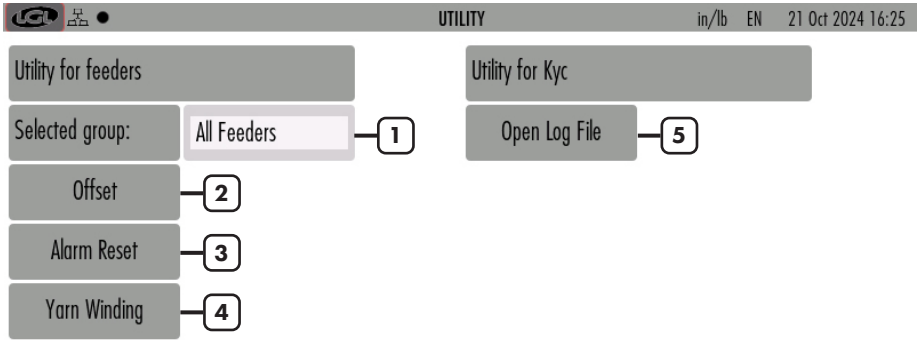

Pic. 17

- 1= Press to select the group of feeders to deal with.
- 2= Offset command (see chapter 5.1).
- 3= Alarm reset command: Reset alarm on selected devices.
- 4= Yarn winding command: only on SPIN and TWIN feeders. Due to this command, feeder can be handled (to thread the yarn for example) without producing reactions from the tension sensors. Feeders do not move.
- 5= Open a log file (located on the SD card) with alarms records coming from the feeders.

5 - SMART UTILITY FUNCTION

5.1 OFFSET

This procedure is related to devices equipped with tension sensor. To be made when by removing the yarn from the tension sensor, the read tension is not zero.

Press "Offset" button:

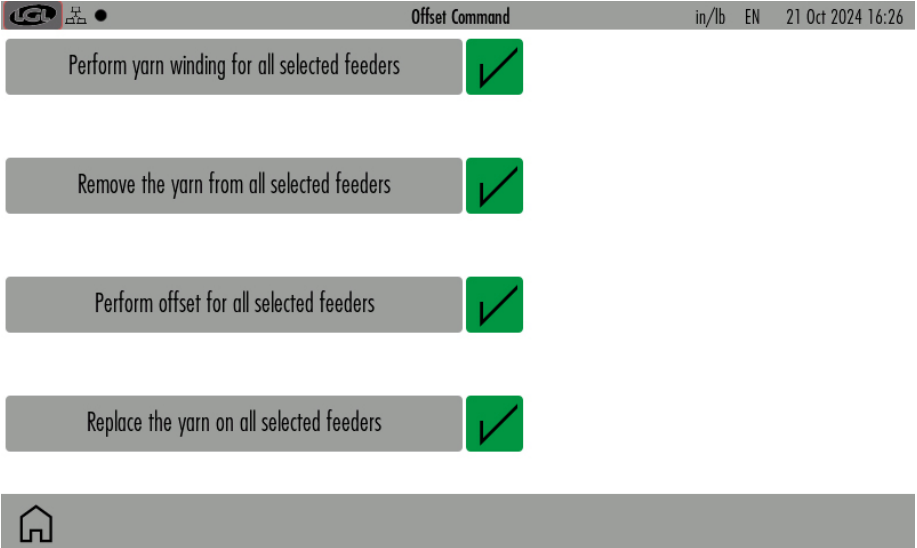

Pic. 18

There are 4 buttons, execute the command written in each button and then press ✓.

First button is valid only on positive feeders TWIN and SPIN. For storage feeders, press this button without any action and go to the second button.

Second button requires to remove the yarn from all load cells. This is very important.

Third button to be pressed only when the action written in the second button has been performed. This button performs the OFFSET command.

Last button reminds to put the yarn back on the load cell.

6 - INFORMATION

From main screen (picture 3) press **i** icon:

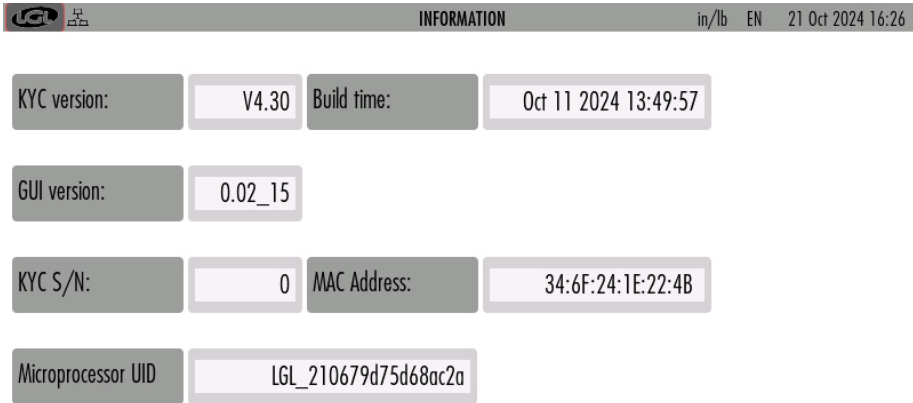

The screenshot shows the 'INFORMATION' screen with a top bar containing the LGL logo, the title 'INFORMATION', and the text 'in/lb EN 21 Oct 2024 16:26'. Below the bar are several rows of data:

KYC version:	V4.30	Build time:	Oct 11 2024 13:49:57
GUI version:	0.02_15		
KYC S/N:	0	MAC Address:	34:6F:24:1E:22:4B
Microprocessor UID	LGL_210679d75d68ac2a		

Copyright (c) 2019 by LGL Electronics - All Rights Reserved Unauthorized distribution is forbidden. For questions about licensing this code, send mail to info@lgl.it



Pic. 19

In this screen the information about device software and hardware is provided.

The icons on the bottom bar are described in the related chapter:



= Diagnostic page (see chapter 6.1)



= KYC firmware update (see chapter 6.2)

6 - INFORMATION

6.1 DIAGNOSTIC PAGE

From picture 19 press  icon:

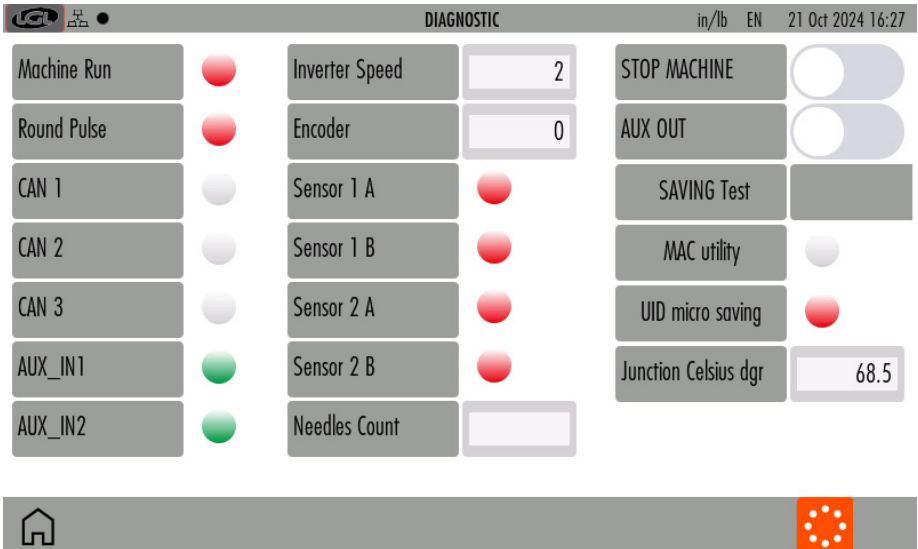

Pic. 20

This screen allows to execute some tests on the signals used by the KYC.

Machine RUN: when the machine starts, the signal goes from red to green. If this does not happen, the connections between KYC and machine must be checked.

Round Pulse: This signal counts the machine turns used for yarn consumption information. It blinks every time the machine beam passes on the revolution sensor. If the signal did not blink at each machine turn, the yarn consumption information could be wrong.

Inverter Speed: This is a number from 0 to 255 that increases when the machine speed increases, and it decreases when the machine speed decreases.

Encoder: If it is connected to the KYC (option), the incremental steps are displayed while the encoder is turning. The KYC uses the Encoder with TWIN feeders to handle their yarn consumption.

Sensor 1A, 1B, 2A, 2B: These concern the two LGL-RPMF sensors (Chapter 9.1 and 10.4). The signal blinks at each turn of the wheel installed on the belt.

MACHINE STOP: STOP signal test. Moving the cursor to the right, the KYC stops the machine allowing a test of the STOP signal going from the KYC to the machine.

SAVING TEST: Test to check if the memory save procedure is correct.

The other voices are for LGL technicians and are not concerning signals tests.

6 - INFORMATION

6.2 KYC FIRMWARE UPDATE

Copy file "KYCTouch4.XX.sec" and the "FILE" folder in the USB root of a USB pen. Insert the USB pen into the KYC device (pic 21):

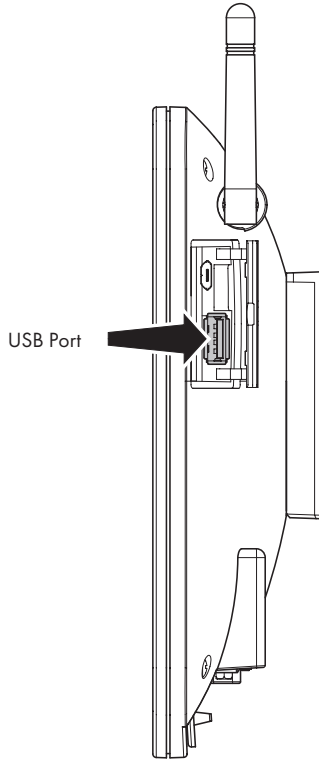

Pic. 21

6 - INFORMATION

From main screen, press **i** and then  :

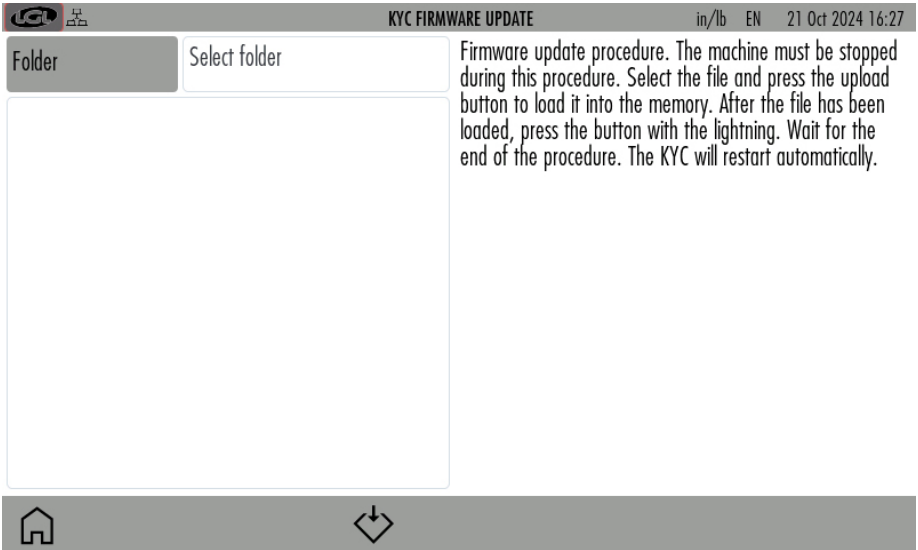

Pic. 22

Press "Select folder" to select the USB root.

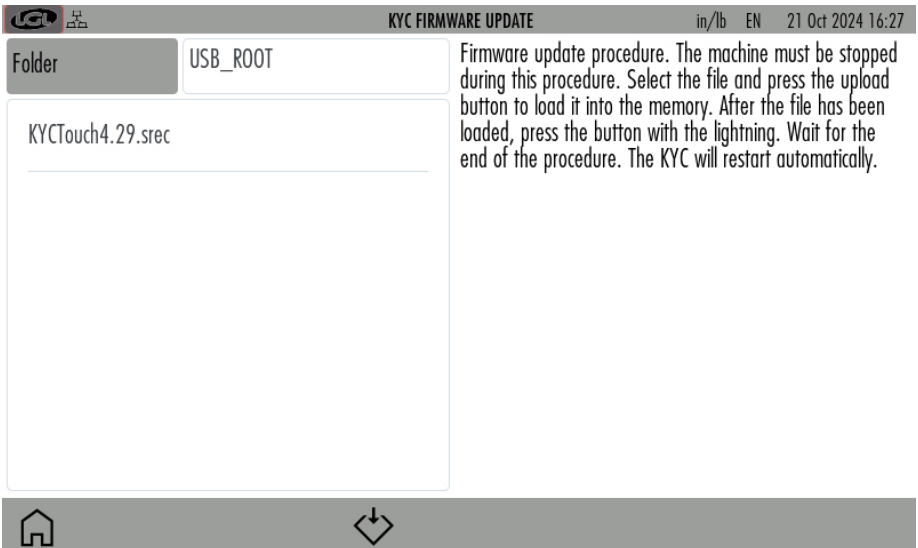

Pic. 23

6 - INFORMATION

Select file "KYCTouch4.XX.srec" and press  to copy the file on the KYC device. A green bar shows the copy in progress. At the end the green bar reaches 100% and it disappears. An icon with thunder shape appears .

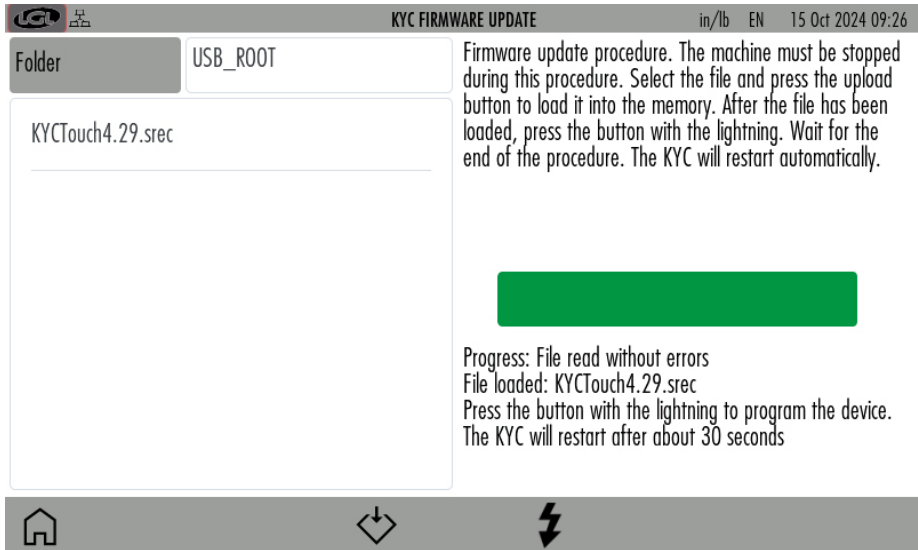

Pic. 24

Pressing icon  the file will be executed, the KYC device turns off and it turns back on after 15 seconds, ready to be used.

NOTE: the system file of the USB pen must be FAT or FAT32.



7 - ACCESS LEVEL

This function allows the operator to set a password to modify parameters on the KYC screen. Two user type have been created: BASE USER and ADVANCED USER. It is possible to create a password for each user.

BASE USER can only display information

ADVANCED USER can display and modify parameters.

The system is set to ADVANCED USER by default and it stays like this if no password is set. By inserting a password for ADVANCED USER, the system can be used as a BASE USER or as an ADVANCED USER.

From main screen (picture 3) press  or  icon:

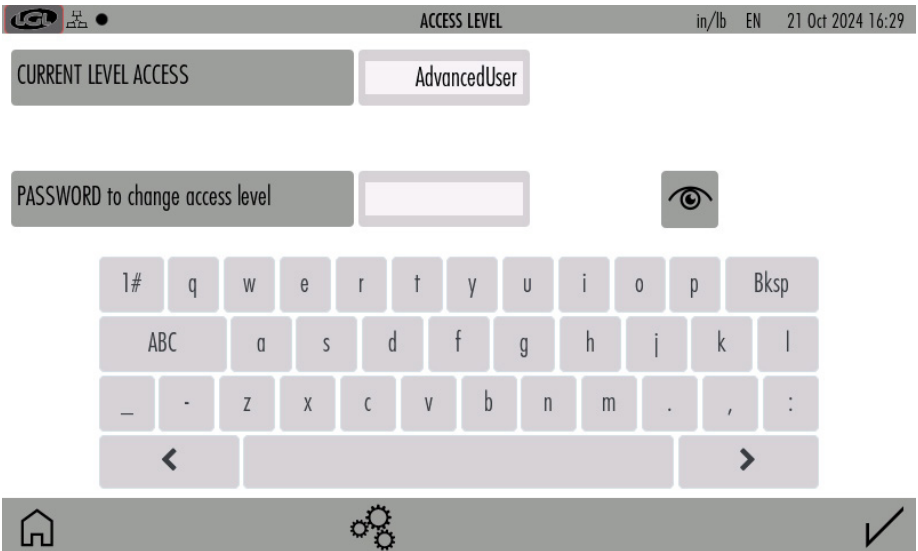

Pic. 25

7 - ACCESS LEVEL

To set the password, press on  icon (Pic. 26):



Pic. 26

Press "Select user" and choose ADVANCED USER, insert password and press  icon. First time do not write anything in the "old password" field.

Important: keep the password in a safe place.

On the main screen (Pic. 3) the BASE USER is identified by icon .

Pressing this icon, you get access to picture 25, where you can pass to ADVANCED USER by inserting the password.

ADVANCED USER is identified on the main screen by icon .

Although possible, it is not strictly necessary to set a password for BASE USER, being this the most limited user. To go back to the base user, press  without inserting any password.

8 - GENERAL SETTINGS

From main screen (picture 3) press  icon:

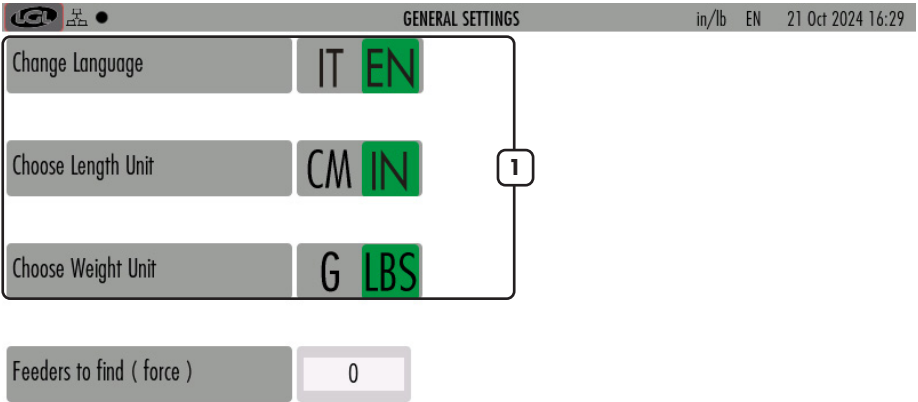

Pic. 27

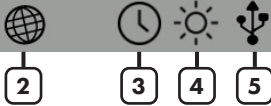

- 1= Press to change unit of measure.
- 2= Network settings (see chapter 8.1)
- 3= Date and clock settings
- 4= Brightness and sleep time settings
- 5= Send file to USB external device. Select the file to send and press > to send it to a USB key device. If you want to delete a file in a SD card, select file and press  (see chapter 10.5)

8 - GENERAL SETTINGS

8.1 NETWORK SETTINGS

Press  icon:

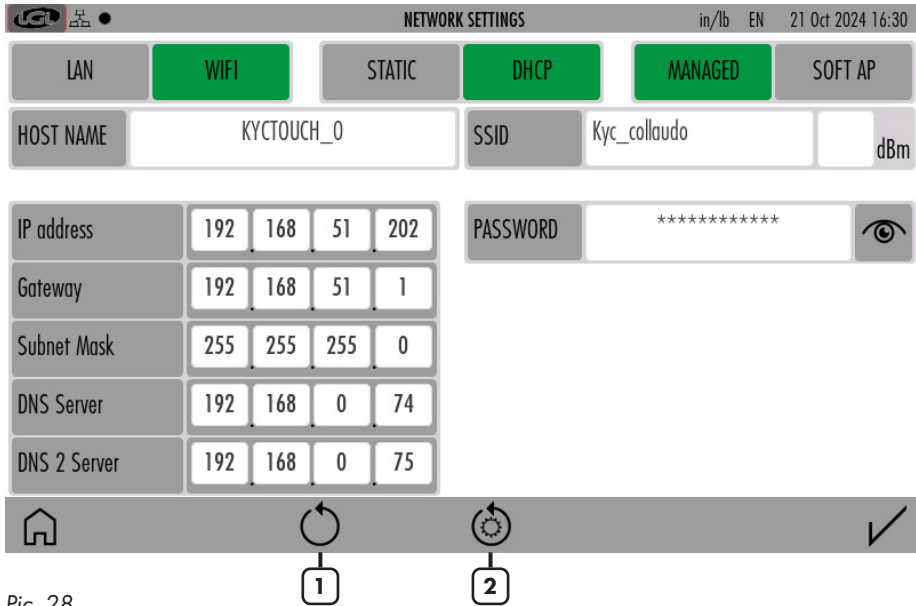

Pic. 28

Modify settings and press ✓ to confirm.

1= Press to scan available access points.

2= Press to reset to default network settings. Press ✓ to confirm.

9 - KLS FUNCTION

KLS function allows feeders to stop the machine if the yarn gets broken between the feeder and the machine (For more information see feeders' manual). This function requires a connection with machine inverter and needs a machine run signal.

On picture 27 (or on picture 3 depending upon versions) press ☀ icon; there are two operation modes: one mode takes the inverter and run signals from the machine itself, and another mode where these signals are taken from a wheel installed on a belt (LGL RPMF sensor):

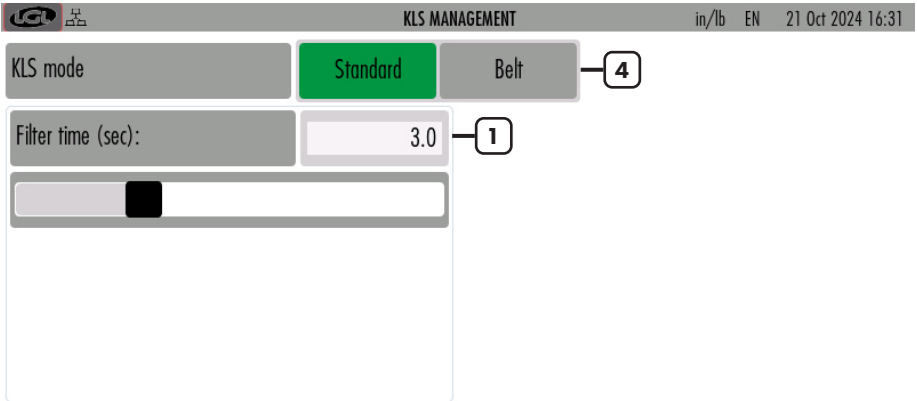

Press START to execute calibration of the output stop motion system.

Do not change default parameters without LGL support

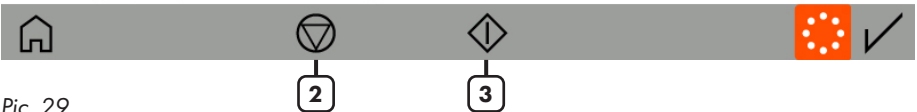

Pic. 29

- 1= Move slide to change KLS "Time filter" (default value 3seconds). This is the time the machine takes to reach production speed.
- 2= Stop KLS control (the machine must be standing).
Attention: the machine won't stop if the yarn gets broken between the feeder and the machine.
- 3= Start KLS control. This button activates the kls system calibration. Start the machine and run it for at least 10 seconds. The stop the machine and re start it. See feeder instructions manual for more information.
- 4= To select where the system takes the RUN and the inverter signal: from the machine or from the LGL RPMF sensor (see chapter 9.1).

Time filter correct timing is 3 seconds which corresponds to the time the machine needs to get to production speed after a start.

9 - KLS FUNCTION

9.1 KLS FUNCTION WITH BELT SENSOR

The KLS function with belt sensor allows feeders to stop the machine if the yarn gets broken between the feeder and the machine, without the use of the inverter signal and the run signal coming from the machine.

Picture 30 shows one LGL-RPMF sensor to be installed on a belt. The sensor has two wheels, and the system handles maximum two sensors.

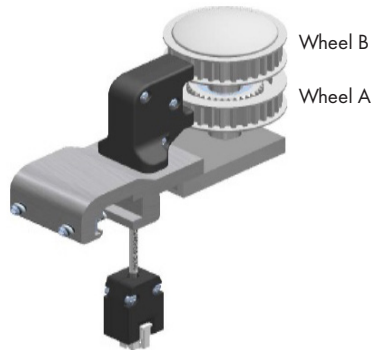

Pic. 30

KLS MANAGEMENT		in/lb	EN	22 Oct 2024 09:05
KLS mode	Standard	Belt		
Yarn delay (20 - 240 cm)	80	1	2	3
Run to Stop delay (0,1 - 4 sec)	0.4	4	5	6
Initial YC (150 - 600 cm)	340	7	8	9
Connect the RPMF sensor in the KYC device position BELT SENSOR 1.		+/-	0	.
Do not change default parameters without LGL support		<	Bksp	>

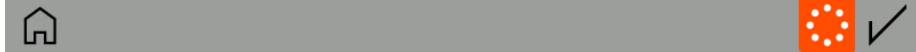

Pic. 31

- Connect the LGL-RPMF to the connector for the LGL- RPMF sensor 1 (see picture 32) . The KYC will recognize the sensor automatically.

9 - KLS FUNCTION

Plug for LGL-RPMF
sensor 1

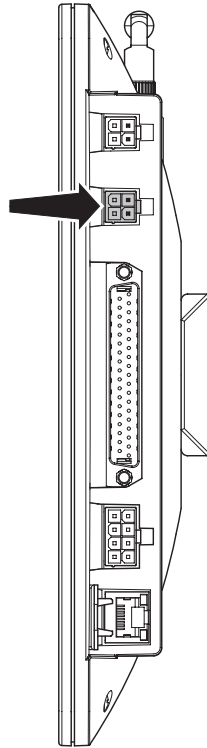

Pic. 32

- b. Select “belt” on the KLS management page (Pic. 31).
- c. If necessary, change the parameters:
 - Yarn delay (20-240cm; default 80cm)
 - Run to stop delay (0,1 – 4 sec; default 0,4 seconds)
 - Initial Yarn consumption (150-600 cm; default 340 cm)

The values in the pictures are the default ones, and they are OK in most cases.

NOTE: This function is enables only on LGL-RPMF sensor 1.

Please make sure that the belt is turning the lower wheel, because the signal is taken form the lower wheel (the Wheel A in picture 30).

The two wheels of the RPMF sensor can be connected to two belts and execute the yarn consumption feature of the belt feeders (chapter 8): the lower wheel will be engaged in two tasks at the same time (see chapter 10.4).

10 - YCM FUNCTION (YARN CONSUMPTION)

From main screen (picture 1) press  icon:

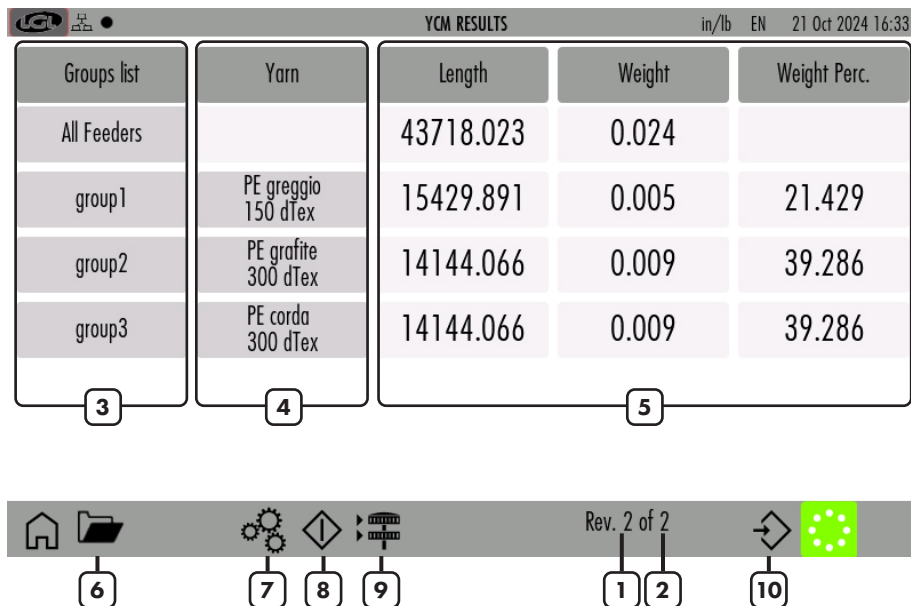

The screenshot shows the 'YCM RESULTS' screen. At the top, it displays 'in/lb EN 21 Oct 2024 16:33'. The main content is a table with five columns: 'Groups list', 'Yarn', 'Length', 'Weight', and 'Weight Perc.'. The table contains four rows of data. Below the table, a bottom navigation bar contains ten icons labeled 1 through 10. The icons are: 1 (Machine revolution Counter), 2 (Complete pattern revolutions), 3 (List of feeders' groups), 4 (Yarn settings), 5 (Yarn consumption values), 6 (Open stored YCM settings), 7 (YCM general settings), 8 (YCM Start/Stop), 9 (Belt feeder settings), and 10 (YCM report saving).

Groups list	Yarn	Length	Weight	Weight Perc.
All Feeders		43718.023	0.024	
group1	PE greggio 150 dTex	15429.891	0.005	21.429
group2	PE grafite 300 dTex	14144.066	0.009	39.286
group3	PE corda 300 dTex	14144.066	0.009	39.286

Pic. 33

- 1= Machine revolution Counter
- 2= Complete pattern revolutions.
- 3= List of feeders' groups. Press on each group button to view data for the feeders in each group (see chapter 10.1)
- 4= Yarn settings for each group. Press "Yarn" to change settings (see chapter 10.2)
- 5= Yarn consumption values
- 6= Open stored YCM settings
- 7= YCM general settings (see chapter 10.3)
- 8= YCM Start/Stop
- 9= Belt feeder settings (see chapter 10.4)
- 10= YCM report saving

To get yarn consumption data, the information described in chapter 10.2, 10.3 and 10.4 must be entered in the system.

The information about machine revolutions in chapter 10.3 is compulsory to get some data. Information shown in chapter 10.2 is required to have the weight and the weight percentage. If this information is not entered, the system will return only the yarn length in centimeters.

10 - YCM FUNCTION (YARN CONSUMPTION)





Belt feeders' settings in chapter 10.4 are necessary in case belt driven feeders are installed on the machine. In this case the system will provide the yarn consumption information of the belt driven feeders together with the LGL devices.

Once the system has been filled with all information, press button  (number 8 in picture 33) to start the calculation. Data will appear on the screen only when the machine gets to the end of the programmed revolution number.

10.1 YCM: FEEDERS IN GROUP

Press one group button. For example, press "group2" in picture 33. Picture 34 appears:

YCM RESULT PER GROUP		in/lb	EN	21 Oct 2024 16:35
group2	Yarn	Length	Weight	Length 100 needles
2 ECM2054	PE grafite 300 dTex	9798.000	2.939	7714.945
5 ECM2054	PE grafite 300 dTex	9798.000	2.939	7714.945
8 ECM2054	PE grafite 300 dTex	9798.000	2.939	7714.945
11 ECM2054	PE grafite 300 dTex	9798.000	2.939	7714.945
14 ECM2054	PE grafite 300 dTex	9798.000	2.939	7714.945
17 ECM2054	PE grafite 300 dTex	9798.000	2.939	7714.945

 Go to feeder			 Rev. 50 of 50		
1	2			3	

Pic. 34

- 1= Insert a feeder number to view single feeder yarn consumption values.
- 2= YCM Start/Stop.
- 3= Press to keep repeating YCM calculation.

10 - YCM FUNCTION (YARN CONSUMPTION)

10.2 YARN SETTINGS

In Picture 33 press the button next to the group name to insert yarn information:

The screenshot displays the 'YARN SETTING' interface. At the top, there is a header bar with the text 'YARN SETTING' and a timestamp 'in/lb EN 21 Oct 2024 16:35'. Below the header, there are four main input fields: 'Selected group:' with the value 'group 1', 'Yarn Type:' with the value 'PE greggio', 'Yarn Count:' with the value '150', and 'Unit of measure:' with a row of radio buttons for 'dTex', 'Tex', 'den', 'Nec', 'New', 'Nej', and 'Nm'. The 'dTex' radio button is selected. Below these fields is a virtual keyboard with keys for letters, numbers, and symbols. At the bottom of the interface, there is a navigation bar with a home icon, a close (X) icon, and a checkmark icon.

Pic. 35

Insert yarn setting for the feeders in the selected group (in this example "group 1"): yarn type, yarn count and measure unit.

The yarn type box can be filled with any feature which characterize the yarn or the pattern.

The yarn consumption will make use of the yarn count only.

10 - YCM FUNCTION (YARN CONSUMPTION)

10.3 YCM GENERAL SETTINGS

From YCM main screen (picture 33) press  icon:

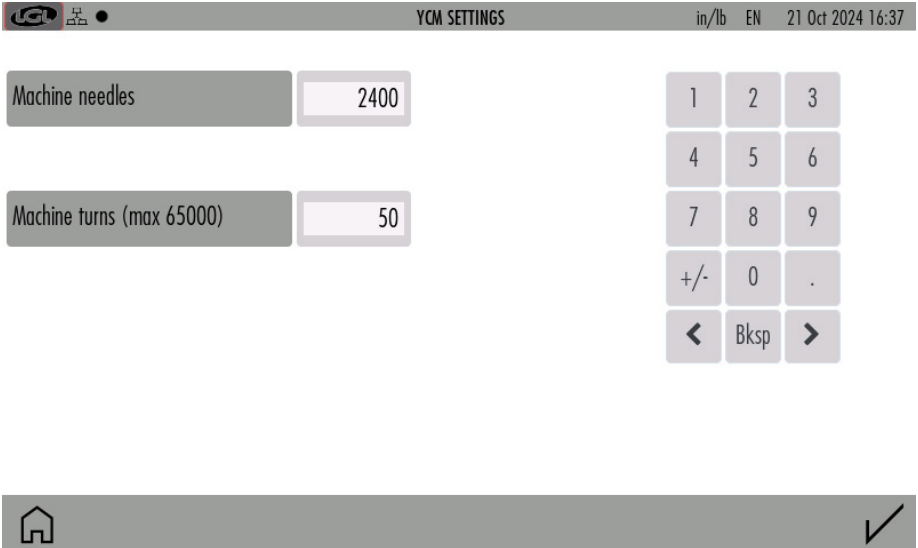

Pic. 36

Insert machine revolution and machine needles to calculate YCM. Information about machine needles is required to provide the length per 100 needles.

10 - YCM FUNCTION (YARN CONSUMPTION)

10.4 BELT FEEDER SETTINGS

The sensor described in this chapter is necessary to calculate the yarn consumption of the belt driven feeders.

When belts sensors are installed, the yarn consumption result will include the length, the weight and the weight percentage of the yarn processed by the total amount of belt feeder connected to the same belt.

For example, if there are 4 wheels which calculate the yarn consumption of 4 belts each belt being connected to a group of belt feeders processing the same yarn, four more voices will be included in the yarn consumption results, one for each belt.

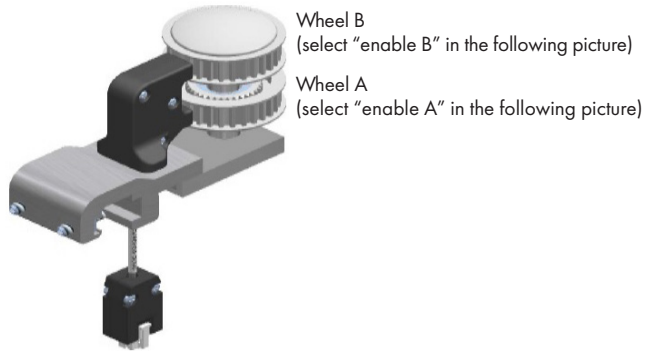

Pic. 37

10 - YCM FUNCTION (YARN CONSUMPTION)

From YCM main screen (picture 33) press  icon:

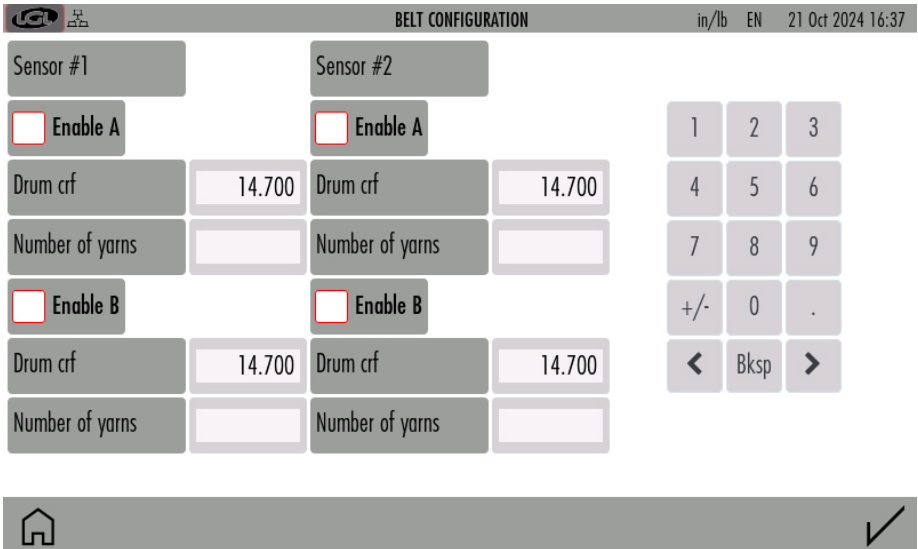

BELT CONFIGURATION				in/lb	EN	21 Oct 2024 16:37
Sensor #1		Sensor #2				
<input type="checkbox"/> Enable A		<input type="checkbox"/> Enable A		1	2	3
Drum crf	14.700	Drum crf	14.700	4	5	6
Number of yarns		Number of yarns		7	8	9
<input type="checkbox"/> Enable B		<input type="checkbox"/> Enable B		+/-	0	.
Drum crf	14.700	Drum crf	14.700	<	Bksp	>
Number of yarns		Number of yarns				

Pic. 38

Select "Enable A" and/or "ENABLE B" to enable belt feeders sensors.
Each sensor can process up to two belts (A and B) and there are two sensors.
The maximum belts number is four.

- Drum crf is the circumference of the belt feeder drum. Insert 14,7cm (default value). As alternative, it is possible to wind up 10 wraps on the belt feeder drum, manually measure the length of such an amount of yarn, divide the value by 10 and insert the value into the parameter. This procedure is more complex, but it is more precise.
- Number of yarns: how many feeds are supplying the same type of yarn. It is possible to use two different yarn types (one for each belt) for each sensor.

10 - YCM FUNCTION (YARN CONSUMPTION)

For example, enabling sensor number 1 and wheel A:

BELT CONFIGURATION
in/lb EN 21 Oct 2024 16:38

Sensor #1	Sensor #2																
<input checked="" type="checkbox"/> Enable A	<input type="checkbox"/> Enable A	<table border="1" style="border-collapse: collapse; width: 100%;"> <tr><td style="padding: 5px;">1</td><td style="padding: 5px;">2</td><td style="padding: 5px;">3</td></tr> <tr><td style="padding: 5px;">4</td><td style="padding: 5px;">5</td><td style="padding: 5px;">6</td></tr> <tr><td style="padding: 5px;">7</td><td style="padding: 5px;">8</td><td style="padding: 5px;">9</td></tr> <tr><td style="padding: 5px;">+/-</td><td style="padding: 5px;">0</td><td style="padding: 5px;">.</td></tr> <tr><td style="padding: 5px;"><</td><td style="padding: 5px;">Bksp</td><td style="padding: 5px;">></td></tr> </table>	1	2	3	4	5	6	7	8	9	+/-	0	.	<	Bksp	>
1	2	3															
4	5	6															
7	8	9															
+/-	0	.															
<	Bksp	>															
Drum crf <input style="width: 80%;" type="text" value="14.700"/>	Drum crf <input style="width: 80%;" type="text" value="14.700"/>																
Number of yarns <input style="width: 80%;" type="text" value="24"/>	Number of yarns <input style="width: 80%;" type="text"/>																
<input type="checkbox"/> Enable B	<input type="checkbox"/> Enable B																
Drum crf <input style="width: 80%;" type="text" value="14.700"/>	Drum crf <input style="width: 80%;" type="text" value="14.700"/>																
Number of yarns <input style="width: 80%;" type="text"/>	Number of yarns <input style="width: 80%;" type="text"/>																



Pic. 39

The yarn consumption result will include the percentages related to the LGL electronic feeders and the percentages related to the belt driven feeders:

YCM RESULTS
in/lb EN 21 Oct 2024 16:39

Groups list	Yarn	Length	Weight	Weight Perc.
All Feeders		140876.891	0.091	
gruppo1	PE greggio 150 dTex	46289.672	0.015	16.872
gruppo2	PE grafite 300 dTex	42432.199	0.028	30.932
gruppo3	PE corda 300 dTex	42432.199	0.028	30.932
Sensor 1 A	lay in 900 dTex	9722.815	0.019	21.263



Pic. 40

10 - YCM FUNCTION (YARN CONSUMPTION)

10.5 YCM REPORT SAVE ON USB PEN

Create and save (to save it press button  10 in picture 33) a YCM report.
Insert a USB pen into the pertinent slot on the back of the KYC.

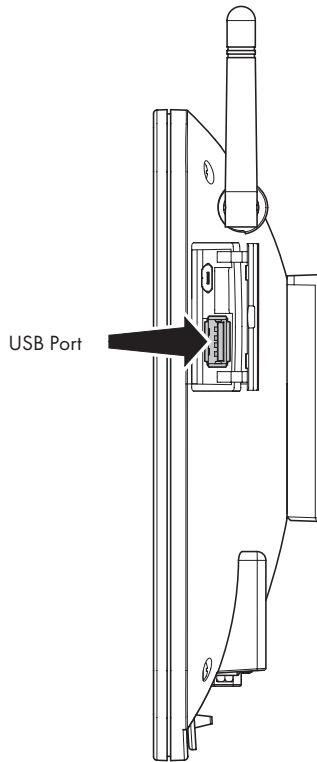

Pic. 41

From main page press  .

10 - YCM FUNCTION (YARN CONSUMPTION)

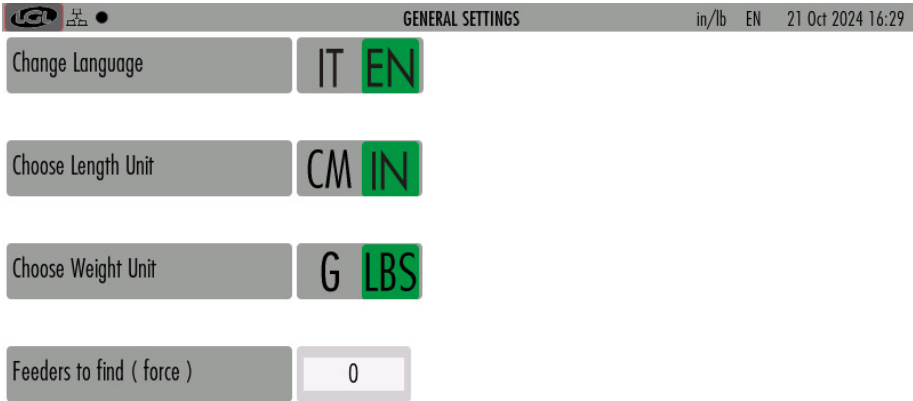

Pic. 42

Press 



Pic. 43

Press Select folder: a drop-down menu will appear. From the menu select YCM. The YCM files created and saved will be shown on the screen:

10 - YCM FUNCTION (YARN CONSUMPTION)

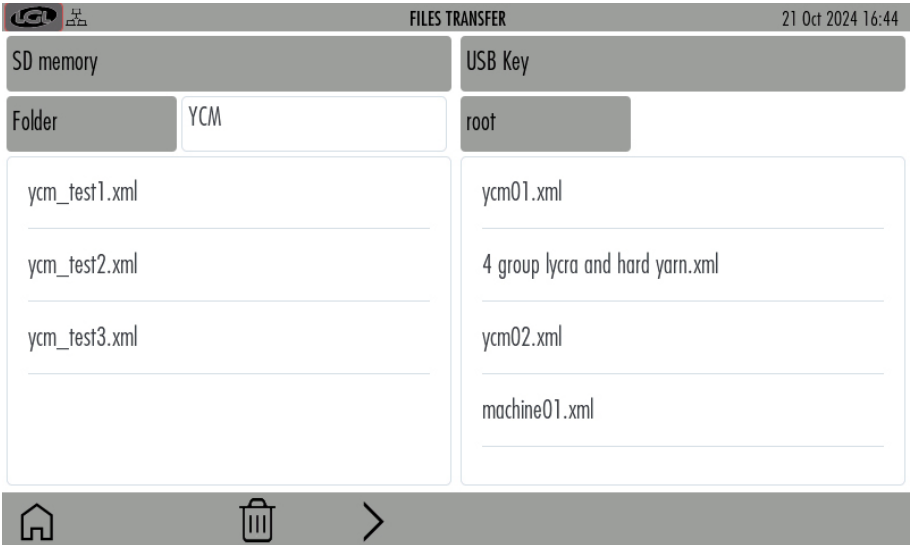

Pic. 44

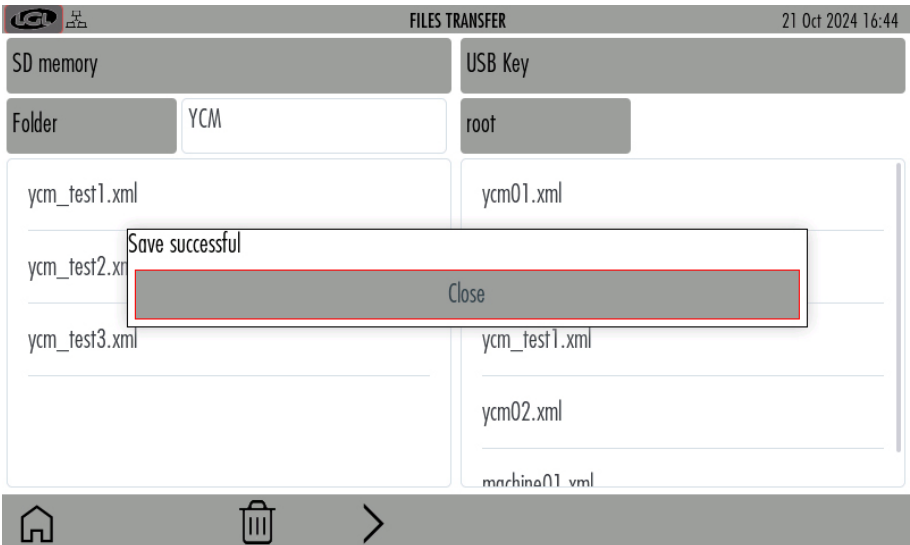

Select the file you want to move to USB pen. Here I selected ycm_test1.xml. Once the file has been selected, an arrow > appears bottom of the screen. Transfer the file to USB pen by pressing the arrow > .



Pic. 45

As the picture shows, the file appears on the right part of the screen, where the files stored in the USB pen are located.

11 - GRAPH OF PARAMETERS

From main screen (picture 3) press  icon and then  :

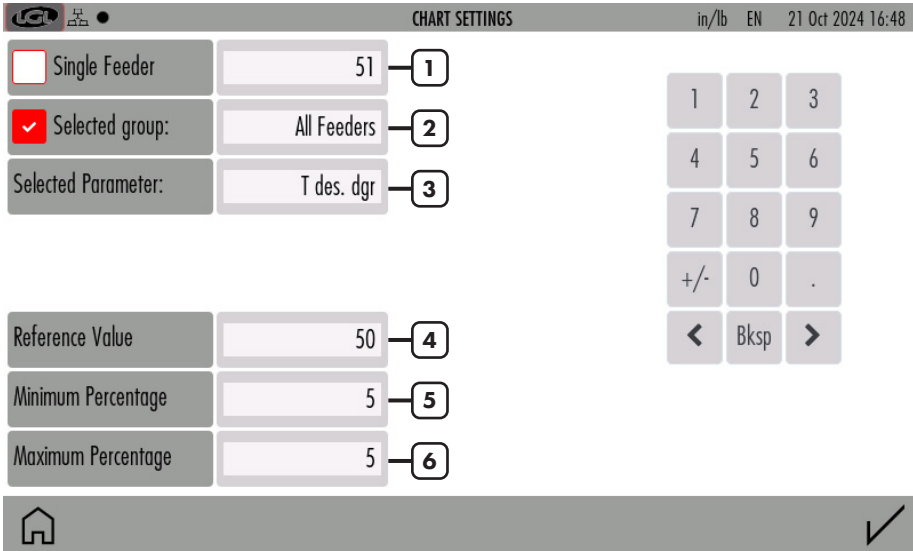

CHART SETTINGS in/lb EN 21 Oct 2024 16:48

Single Feeder 51 **1**

Selected group: All Feeders **2**



Selected Parameter: T des. dgr **3**

Reference Value 50 **4**

Minimum Percentage 5 **5**

Maximum Percentage 5 **6**

1 2 3
4 5 6
7 8 9
+/- 0 .
< Bksp >

 

Pic. 46

- 1= Select if you want to see the chart of one feeder only.
- 2= Select if you want to see the graph of all feeders in the selected group. To select a group, press on "All Feeders".
- 3= Select parameter.
- 4= It is possible enter a reference value with a control percentage. If the read value differs from the input information, the feeder's bar on the chart will turn red.
- 5= Minimum allowed value (%).
- 6= Maximum allowed value (%).

11 - GRAPH OF PARAMETERS

In the end press icon ✓ to display the requested diagram:

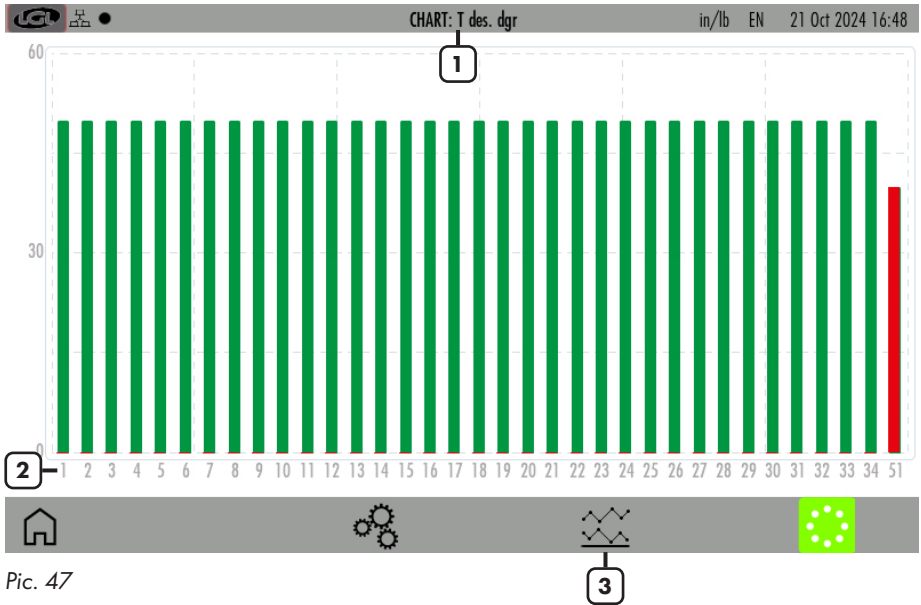

Pic. 47

- 1= Parameter shown (Tread in the example).
- 2= Addresses of the feeders. If the screen is not large enough to fit all feeders, some arrows will appear bottom of the screen to allow a scrolling.
- 3= Press to view chart of minimum and maximum read value (Pic. 48)

The diagram shown the parameter's value for all connected feeders. Each rectangle is green if its value is within the tolerance defined by the minimum and maximum percentage (Pic 46). On the contrary if the value is out of tolerance, the rectangle is red.

11 - GRAPH OF PARAMETERS

The minimum and maximum values of the parameter are shown in picture 48. The blue line shows minimum values, while the red line shown maximum values.

This diagram is important for read parameters coming from sensors, like the read yarn tension of this example.

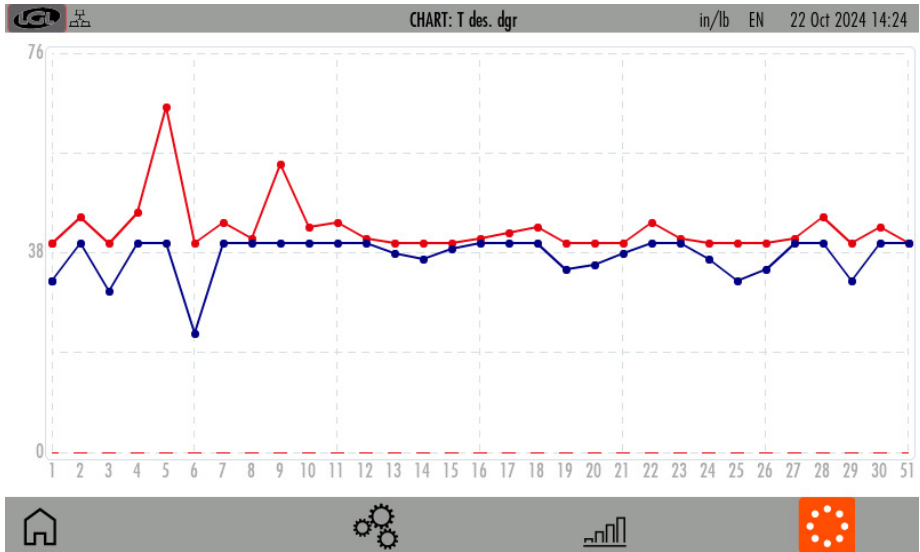

Pic. 48

12 - SYNCHRONOUS YARN FEEDING FUNCTION (SYF)

This function is available only on TWIN feeder equipped with board LGL272 and it is used to produce plain fabric. It is not available on any other LGL product.

The KYC system must be connected to an encoder synchronized with the machine (available in LGL). The encoder must be connected to the KYC through a connector designed for this purpose. And shown in the following picture:

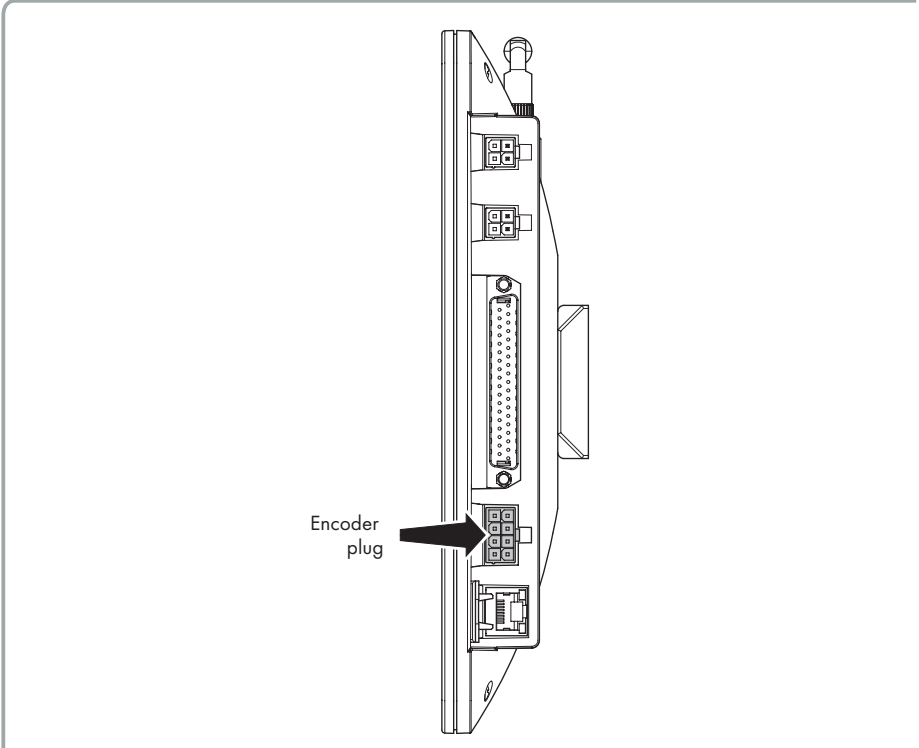

Pic. 49

The TWIN feeder works synchronous with the machine, thus releasing a constant amount of yarn. The tension sensor is used to provide the information about the yarn tension and to give alarms if the tension goes out of tolerance.

12 - SYNCHRONOUS YARN FEEDING FUNCTION (SYF)

From main screen (picture 3) press  icon:

in/lb		EN		21 Oct 2024 16:52	
Groups list	Status	T.des Coherence	Desired Value	T.des value	
All Feeders	Not consistent	Not consistent	40	40	
group1	ENABLED	Not consistent	40	40	
group2	ENABLED	Consistent	40	40	
group3	DISABLED	Consistent	0	40	
1	2	3	4	5	



Pic. 50

- 1= Groups list.
Press on each group tab to perform tuning (see dedicated sub-chapter 12.1)
- 2= Status of synchronous yarn feeding per each group (read only):
ENABLED: SYF function enabled.
All feeders in each group provide the same amount of yarn.
DISABLED: SYF function disabled.
All feeders in each group work with the tension sensor.
Not consistent: The feeders in the group have different SYF values from one another.
- 3= Coherence of the desired tension value during tuning procedure.
Consistent: All feeders in group have the same tension value
Not consistent: All feeders in the group have different desired tension values.
The desired tension values must be modified to be all same for the same group.

12 - SYNCHRONOUS YARN FEEDING FUNCTION (SYF)

- 4= Desired yarn consumption value in cm/revolution. Press to change value. This value can be set through the calibration procedure or it can be written directly in this position.

NOTE: After pressing on the value, a new picture appears:

The screenshot shows a control interface for parameter adjustment. At the top, a status bar displays 'PARAMETER VALUE CHANGE' along with units 'in/lb', language 'EN', and a timestamp '21 Oct 2024 16:52'. Below this, there are several input fields and a numeric keypad. The 'Selected group' field contains 'group3'. The 'Parameter' field is set to 'Desired Value', and the 'Present Value' field shows '0'. An 'Insert new value' field is empty. To the right is a numeric keypad with digits 1-9, '+/-', '0', '.', and navigation arrows. At the bottom, a navigation bar contains a home icon, a triangle-in-circle icon, and a checkmark icon.

Pic. 51

by pushing , the SYF function for the group will be disabled and each feeder will work in tension mode.

- 5= Desired tension. Press to change value. Also, in this case appears picture 51. Insert the new value in the pertinent box.

12 - SYNCHRONOUS YARN FEEDING FUNCTION (SYF)

12.1 SYF TUNING

Press a group tab in picture 50 to perform SYF tuning. The tuning sets a constant yarn consumption on the group. See Pic.52:

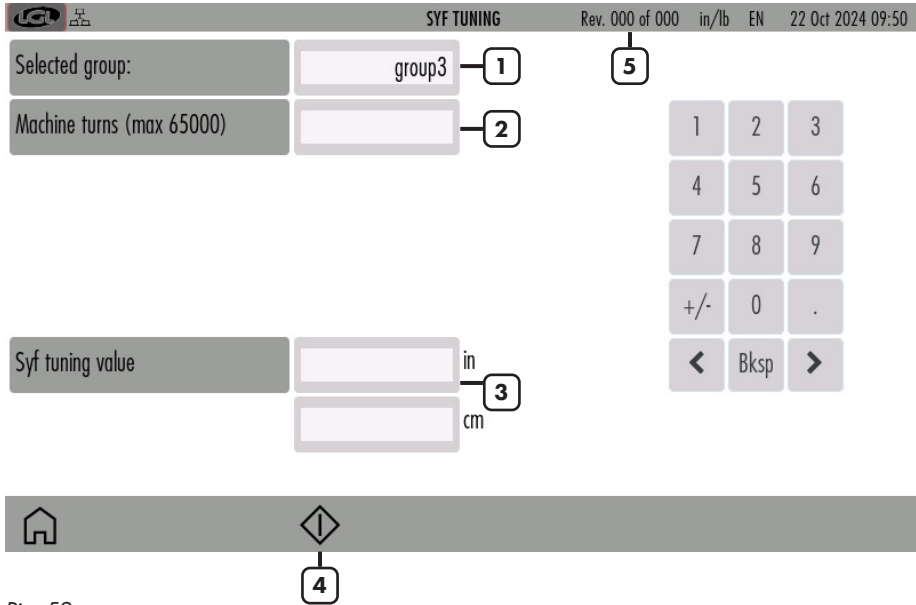

Pic. 52

- 1= Group selected.
- 2= Duration of the SYF tuning procedure in number of machine revolutions.
- 3= When the tuning procedure is over, the yarn consumption value will be shown here.
- 4= Press to start/stop tuning procedure.
- 5= The number of machine revolutions will increase from 0 to the preset value (see in box number 2) during tuning.

When the tuning procedure is over, the yarn consumption value is shown, and the symbol ✓ appears.

Press ✓ to send the value to all feeders and to enable the SYF function.

12 - SYNCHRONOUS YARN FEEDING FUNCTION (SYF)

12.2 SYF IN STANDBY MODE

This button  appears top right of the main screen if there are Twin feeders equipped with SYF function.

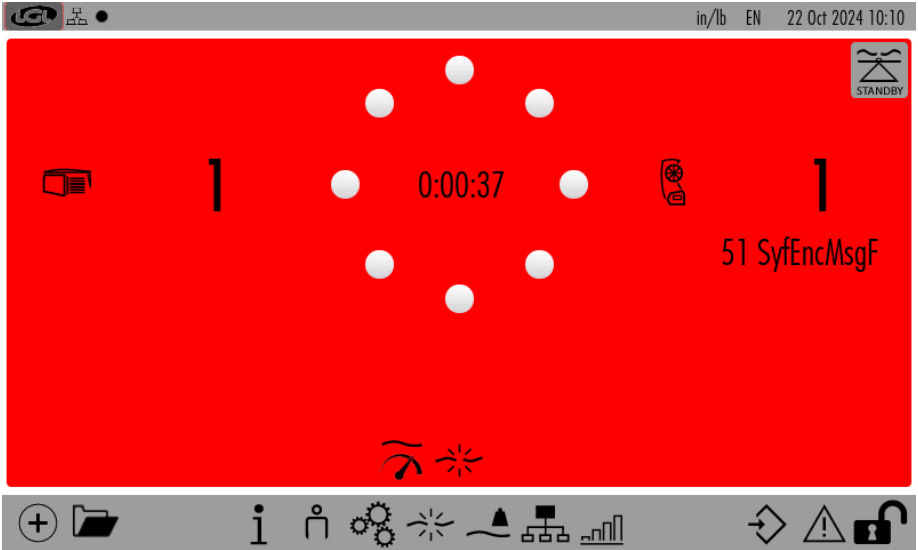

Pic. 53

This button allows the operator to stop the SYF function for five revolutions. Twin feeders will work in tension mode during these revolutions.

Press icon  (Pic.53). TWIN feeders will change from consumption mode to tension mode. The feeders' lights will go from yellow (consumption mode) to green (tension mode).

Twin feeders will work in tension mode for five revolutions, then they will return automatically to Consumption mode.

13 - YARN SPEED CONTROL (YSC)

This function is available only on Ecompact and Ecopower feeders DC versions.

YSC is a function which allows the feeder equipped with ATTIVO system to control the yarn consumption reference (yarn consumption mode) during plain knitting fabric, and the tension reference (tension mode) during Jacquard patterns.

Feeders can automatically pass from one mode to the other when the pattern passes from plain to jacquard and viceversa.

From main screen (picture 4), press  icon:

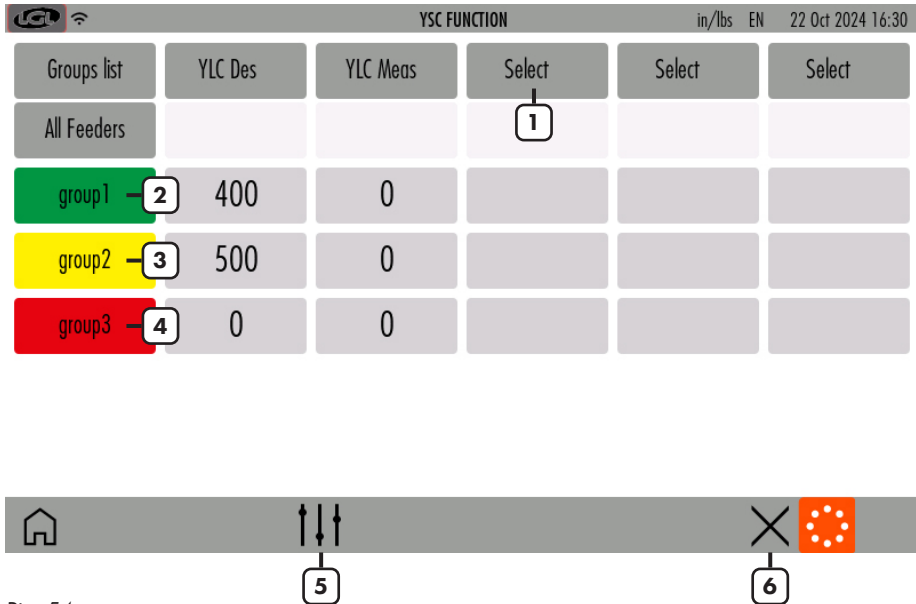

Pic. 54

- 1= Press to select YSC parameters (see chapter 13.2 which shows the engaged parameters).
- 2= The rectangle is green because the YSC is active and all feeders in the group have the same value
- 3= The rectangle is yellow because the YSC is active but there are the feeders with different values in the same group. In this case the calibration must be repeated.
- 4= The rectangle is red because the YSC is not active for all feeders in the group.
- 5= Tuning button (see 13.1 chapter).
- 6= Button to disable YSC to all feeders. Verify desired tension as it may have changed during YSC.

13 - YARN SPEED CONTROL (YSC)

13.1 YSC TUNING

From YSC screen press ↑↓↑ icon:

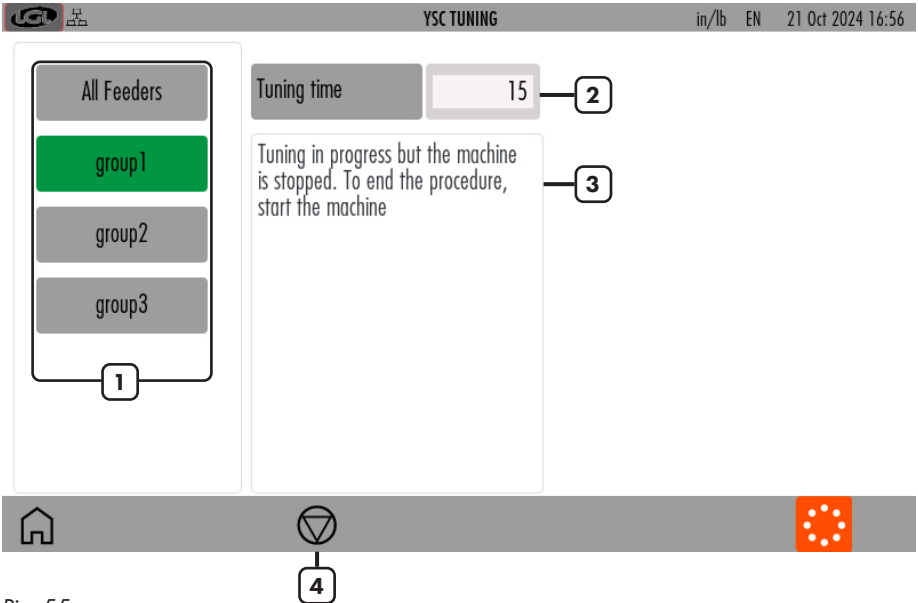

Pic. 55

- 1= Press and hold to select or deselect a group (green= yarn consumption mode; grey= tension mode).
- 2= Change tuning time (default value=15. Normally it is not necessary to change this number).
- 3= Information: tuning in progress and end of procedure.
- 4= Button to start or stop tuning procedure.

13 - YARN SPEED CONTROL (YSC)

13.2 YSC PROCEDURE

The pattern must be plain, all feeders of the same group must consume the same amount of yarn. Select the groups which you require to run in yarn consumption mode.

If the machine is running, stop it.

Press tuning procedure button (number 4 in picture 55)

Run the machine and wait until the end of the tuning procedure. After about 30 seconds the tuning is over. From that moment on the YSC function is active and working.

In the YSC main screen each group working in consumption mode will be green and each feeder of the group will adjust the same yarn consumption by moving the Attivo brake. This means that the tensions values will change (and they will be different on each feed) to keep the preset yarn consumption.

Each group working in tension mode will be grey.

On the screen it is possible to display the parameters which are involved in this function:

- **YLC Meas:** this is the actual yarn consumption (read only, in cm/2s).
- **YLC Des:** this is the desired yarn consumption set during tuning procedure (read /write, in Cm/2s). Each feeder keeps this parameter constant by modifying the desired tension.
- **YLCT.min:** minimum tension permitted by YSC system (default 2g). If the yarn tension T_{des} gets to T_{min} during YSC working, YSC stays active, even if the tension won't go below T_{min} .
- **YLCT.max:** maximum tension permitted by YSC system (default 7g). If the yarn tension T_{des} gets to T_{max} during YSC working, YSC stays active, even if the tension won't go above T_{max} .

Both T_{min} and T_{max} can depend on the mechanics of the output brake. In fact the output brake could not be able to achieve a too high or a too low tension.

- **YLC%max:** maximum variation of real time yarn consumption above which YSC system is disabled. This parameter defines a limit between a plain area and a jacquard area of the same pattern. When the yarn consumption overcomes %max, it means that the pattern is no more plain and that feeder must work in tension mode. The tension each feeder adjusts is the very last it was adjusting during consumption mode (default 10%).
- **YLCTdesTun.:** tension of the ATTIVO system during tuning procedure. During tuning procedure ATTIVO is working in tension mode, and this is the tension at which the system records the yarn consumption parameters.

14 - WAPER FUNCTION (ONLY FOR TWIN FEEDERS)

This function is available only for Twin units, and it is required when the unit is installed on a warper in order to automatically set the feeders which are involved in the warp production and the ones which will not be used.

From main screen (picture 4) press  icon:

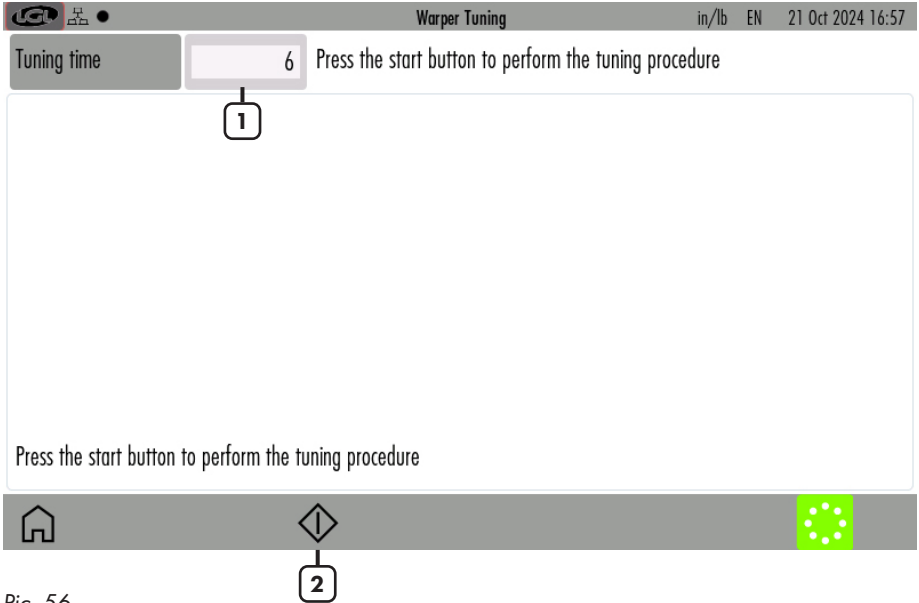

Pic. 56

- 1= Time of tuning (default 6 seconds).
- 2= Press to start tuning procedure. When the start button is pressed the stop button will appear to manually stop the tuning. Then start the machine.

14 - WARPER FUNCTION (ONLY FOR TWIN FEEDERS)

At the end of the tunin, the result will be shown in the following screen:

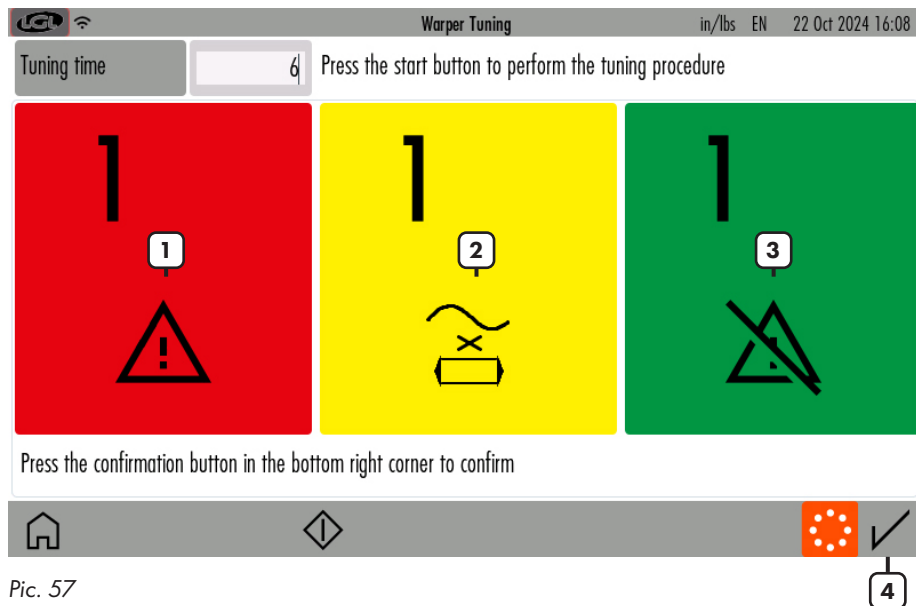

Pic. 57

- 1= Feeder in alarm (different from "YrnStanding A")
- 2= Feeder in "Yrn Standing A"
- 3= Feeder not in alarm
- 4= Confirm button

If the result is as expected, press the confirmation button.

Once the tuning is over and the operator presses the confirmation button, all green feeders will be supposed to work in the next warp production, while the red and the yellow ones are not supposed to work.

This means that if one feeder which is supposed to work does not turn, it will stop the machine, as well as if one feeder that is not supposed to work is actually turning.

15 - DATA ANALYSIS AND REMOTE CONTROL

This function is available in combination with LGL KYC touch device from KYC software version 4.19.

Data Analysis consists in monitoring the feeders' parameters on the long run, with the target to offer predictive maintenance and suggestions to improve machines efficiency.

Remote control allows an LGL technician to check the feeders from remote in case of a problem. From main screen (picture 4) press  icon:

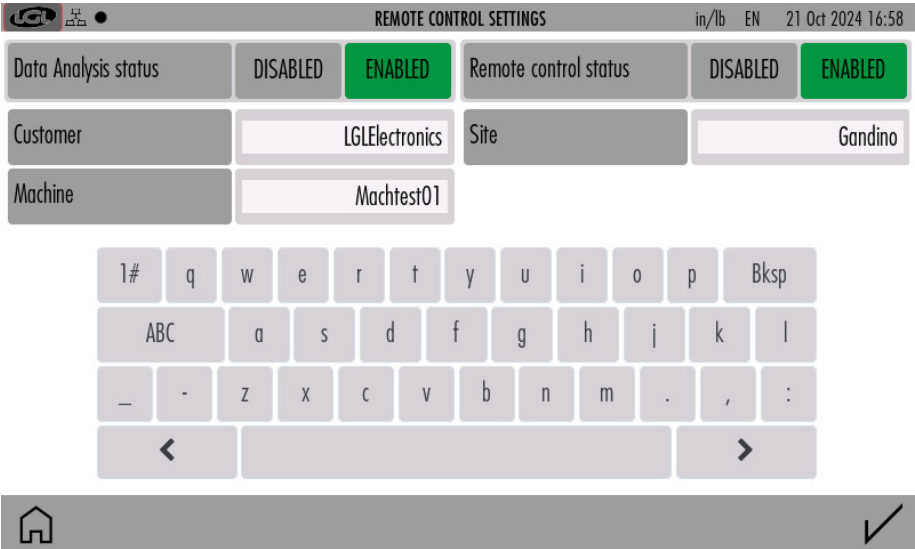

Pic. 58

If you want to enable data analysis, select enable with relative button, insert information about customer, site and machine and press  to confirm.

If you want to disable data analysis, select disable with relative button and press  to confirm.

If you want to enable remote control, select enable with relative button and press  to confirm.

If you want to disable remote control, select enable with relative button and press  to confirm.

Once confirm button  is pressed, the kyc device will recycle power to enable the changes.

EU DECLARATION OF CONFORMITY
DICHIARAZIONE DI CONFORMITÀ UE

We,
Noi,

Manufacturer / *Fabbricante*: **LGL Electronics S.p.A.**
Address / *Indirizzo*: Via Ugo Foscolo, 156
24024 Gandino BG - Italy

declare under our sole responsibility that the radio equipment
dichiariamo sotto la nostra unica responsabilità che l'apparecchiatura radio

Object of the Declaration: <i>(Identification of the radio equipment)</i> Oggetto della Dichiarazione: <i>(identificazione dell'apparecchiatura radio)</i>	Touch screen terminal
Type/Model: <i>Tipo/Modello</i> :	KYC TOUCH
Firmware Version: <i>Versione del Firmware del/dei modulo/i radio</i>	IW416-V0, RF878X, FP91, 16.91.10.p214, WPA2_CVE_FIX 1, PVE_FIX 1
Intended use: <i>Impiego previsto</i>	communication interface and gateway between yarn feeders installed on knitting machines and the user interfaccia e gateway di comunicazione tra gli alimentatori di filo installati su macchine da maglieria e l'utente
Description of accessories and components which allow the radio equipment to operate as intended (approved antenna types, software, ...)	Antenna: Linx Technologies cod. ANT-DB1- LCD-RPS Antenna: Linx Technologies cod. ANT-DB1- LCD-RPS

*Descrizione degli accessori e dei componenti che
consentono all'apparecchiatura radio di funzionare
come previsto (tipi di antenne approvate, software, ...)*

**is in conformity with the essential requirements of the Directive 2014/53/EU (RED) and of the
Directive 2011/65/EU (RoHS II), including subsequent revisions and additions, as well as amended
by the Delegated Directive 2015/863/EU (RoHS III).**

*è conforme ai requisiti essenziali della Direttiva 2014/53/UE (RED) e della Direttiva 2011/65/UE
(RoHS II) comprese successive revisioni ed integrazioni, così come modificata dalla Direttiva*

Delegata 2015/863/UE (RoHS III)."

**The product has been tested according to the following standards or technical specifications:
Il prodotto è stato testato in base alle seguenti norme o specifiche tecniche:**

1. Essential requirements for the protection of the health and safety of people, pets and goods, Article 3.1a) of Directive 2014/53/UE:
Requisiti essenziali per la protezione della salute e della sicurezza di persone e di animali domestici e beni, Articolo 3.1a) della Direttiva 2014/53/UE:

EN IEC 62368-1:2020+A11:2020

EN IEC 62311:2020

2. Essential requirements on electromagnetic compatibility levels, Article 3.1b) of Directive 2014/53/UE:
Requisiti essenziali per i livelli di compatibilità elettromagnetica, Articolo 3.1b) della Direttiva 2014/53/UE:

- ETSI EN 301 489-1 V2.2.3
 - ETSI EN 301 489-17 V3.2.4
- Additional standards:
- EN IEC 61000-6-2:2019
 - EN 61000-6-4:2007 + A1:2013

3. Essential requirements for the effective use of radio spectrum, Article 3.2 of Directive 2014/53/UE:
Requisiti essenziali per l'uso efficace dello spettro radio, Articolo 3.2 della Direttiva 2014/53/UE:

- ETSI EN 300 328 V2.2.2
- ETSI EN 301 893 V2.1.1

4. Requirements of Directive 2011/65/UE (RoHS II) towards the maximum tolerated concentrations of the substances listed in Annex II as amended by the Delegated Directive 2015/863/EU (RoHS III):
Requisiti della Direttiva 2011/65/UE (RoHS II) nei confronti delle concentrazioni massime tollerate delle sostanze elencate nell'Allegato II come modificata dalla Direttiva Delegata 2015/863/UE (RoHS III):

- EN IEC 63000:2018

The Notified Body Nemko S.p.A. performed the conformity assessment of the technical documentation according to the procedure of Annex III (Module B) of Directive 2014/53/EU and issued the EU-type examination certificate no. 2051-RED-242302.

L'Organismo Notificato Nemko S.p.A. ha effettuato la valutazione della conformità della documentazione tecnica secondo la procedura di cui all'Allegato III (modulo B) della Direttiva 2014/53/UE e ha rilasciato il certificato di esame UE del tipo n° 2051-RED-242302.

Signature of the Legal representative:

Firma del Rappresentante legale:

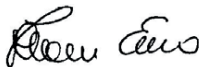



L.G.L. Electronics S.p.A. reserve the right to alter in any moment one or more specifications of his machines for any technical or commercial reason without prior notice and without any obligation to supply these modifications to the machines, already installed.

T +39 035 733 408 **L.G.L. Electronics S.p.A.**
F +39 035 733 146 Via Ugo Foscolo, 156
lgI@gl.it 24024 Gandino (BG)
www.lgl.it Italy